





**BUREAU
VERITAS**

TEST REPORT AS/NZS 4777.2

Grid connection of energy systems via inverters Part 2: Inverter requirements

Report reference number: PVAU160721N056-R2				
Date of issue: 2017-08-07				
Total number of pages: 175				
Testing laboratory name: Bureau Veritas Shenzhen Co., Ltd. Dongguan Branch				
Address: No. 34, Chenwulu Section, Guantai Rd., Houjie Town, Dongguan City, Guangdong 523942, China				
				
Applicant's name: Shenzhen SOFARSOLAR Co., Ltd.				
Address: 5L, Fourth Building, Antongda Industrial Park, Liuxian Avenue No.1, Xinan Street, Baoan District, Shenzhen, China.				
Test specification				
Standard.....: AS/NZS 4777.2:2015				
Certificate: Certificate of compliance				
Test report form number: AS4777_C				
Master TRF: Bureau Veritas Consumer Products Services Germany GmbH				
Test item description: Grid connected photovoltaic inverter				
Trademark.....: 				
Model / Type: SOFAR 10000TL-Sx Series, SOFAR 15000TL-Sx Series, SOFAR 17000TL-Sx Series, SOFAR 20000TL-Sx Series,				
Ratings	SOFAR 10000TL-Sx Series	SOFAR 15000TL-Sx Series	SOFAR 17000TL-Sx Series	SOFAR 20000TL-Sx Series
Maximum input DC voltage [V].....:	1000			
Operating input DC voltage range [V]:	250 - 960			
Full load MPPT input DC voltage range [V].....:	350 - 850	370 - 850	420 - 850	430 - 850
Input DC current [A]	Max. 15,0 x 2	Max. 21,0 x 2		Max. 24,0 x 2
Output AC voltage [V]	230, 50Hz			
Output AC current [A].....:	Max. 3 x 15,0	Max. 3 x 22,0	Max. 3 x 25,0	Max. 3 x 29,0
Output power [VA].....:	10000	15000	17000	20000

Testing Location	Bureau Veritas Shenzhen Co., Ltd. Dongguan Branch
Address	No. 34, Chenwulu Section, Guantai Rd., Houjie Town, Dongguan City, Guangdong 523942, China
Tested by (name and signature)	Sean Tu 
Approved by (name and signature)	James Huang 
Manufacturer's name	Shenzhen SOFARSOLAR Co., Ltd.
Factory address	5L, Fourth Building, Antongda Industrial Park, Liuxian Avenue No.1, Xinan Street, Baoan District, Shenzhen, China.

Document History			
Date	Internal reference	Modification / Change / Status	Revision
2016-08-29	Sean Tu	Initial report was written	0
2016-09-01	Sean Tu	- Add Inverter topology DRM mode marking - Correct the Verdicts of clause 6.3.5.3 and 6.3.5.4 - Add the deviation tests of New Zealand	1
2017-08-07	James Huang	Add the test results in table 7.3	2
Supplementary information:			

Test items particulars	
Equipment mobility	Permanent connection
Operating condition	Continuous
Class of equipment	Class I
Protection against ingress of water ..	IP65 according to EN 60529
Mass of equipment [kg]	45kg for SOFAR 10000TL-Sx Series, SOFAR 15000TL-Sx Series; 48kg for SOFAR 17000TL-Sx Series, SOFAR 20000TL-Sx Series;
Test case verdicts	
Test case does not apply to the test object	N/A
Test item does meet the requirement	P(ass)
Test item does not meet the requirement	F(ail)
Testing	
Date of receipt of test item	2016-07-21
Date(s) of performance of test	2016-07-21 to 2017-08-03
General remarks:	
<p>The test result presented in this report relate only to the object(s) tested. This report shall not be reproduced, except in full, without the written approval of the applicant. "(see Annex #)" refers to additional information appended to the report. "(see appended table)" refers to a table appended to the report. Throughout this report a comma is used as the decimal separator. The unit was reviewed to AS 4777.2:2015 Grid connection of energy systems via inverters – Part 2: inverter requirements and the unit fulfils the requirements of the European EMC directive requirements. The EMC requirements of AS 4777.2 (flicker) refer to the same standards as the EMC directive; therefore the EMC report documents show the compliance.</p>	
This Test Report consists of the following documents:	
<ul style="list-style-type: none"> - Test Results - Annex No. 1 – EMC Test Report - Annex No. 2 – Pictures of the unit - Annex No. 3 – Test equipment list 	

Copy of marking plate:

SOFAR SOLAR Solar Inverter
光伏并网逆变器

Sofar 10000TL-Sx Series

Max. DC input voltage(最大直流输入电压):	1000V
Operating MPPT voltage range(MPPT电压范围):	250-960V
Max. Input current(最大输入电流):	2x15A
Max. PV Isc(最大输入短路电流):	2x20A
Nominal Grid Voltage(额定电网电压):	3/N/PE, 230/400V~
Max. Output Current(最大输出电流):	3x15A
Nominal Grid Frequency(额定电网频率):	50Hz
Max. Output power(最大输出功率):	10000VA
Power factor(功率因数):	>0.99(adjustable+/-0.8)
Ingress protection(IP等级):	IP65
Operating Temperature Range(运行环境温度):	-25~+60°C
Protective Class(保护级别):	Class I
Made in China(中国制造)	

Manufacturer: Shenzhen SOFARSOLAR Co., Ltd.
制造商: 深圳市首航新能源有限公司
SAA140078
VDE0126-1-1, VDE-AR-N4105, G83/2, EN50438, C10/11, RD1699, UTE C15-712-1, AS4777



SOFAR SOLAR Solar Inverter
光伏并网逆变器

Sofar 15000TL-Sx Series

Max. DC input voltage(最大直流输入电压):	1000V
Operating MPPT voltage range(MPPT电压范围):	250-960V
Max. Input current(最大输入电流):	2x21A
Max. PV Isc(最大输入短路电流):	2x27A
Nominal Grid Voltage(额定电网电压):	3/N/PE, 230/400V~
Max. Output Current(最大输出电流):	3x22A
Nominal Grid Frequency(额定电网频率):	50Hz
Max. Output power(最大输出功率):	15000VA
Power factor(功率因数):	>0.99(adjustable+/-0.8)
Ingress protection(IP等级):	IP65
Operating Temperature Range(运行环境温度):	-25~+60°C
Protective Class(保护级别):	Class I
Made in China(中国制造)	

Manufacturer: Shenzhen SOFARSOLAR Co., Ltd.
制造商: 深圳市首航新能源有限公司
SAA140078
VDE0126-1-1, VDE-AR-N4105, G59/3, IEC61727, IEC62116, C10/11, RD1699, UTE C15-712-1, AS4777



SOFAR SOLAR Solar Inverter
光伏并网逆变器

Sofar 17000TL-Sx Series

Max. DC input voltage(最大直流输入电压):	1000V
Operating MPPT voltage range(MPPT电压范围):	250-960V
Max. Input current(最大输入电流):	2x21A
Max. PV Isc(最大输入短路电流):	2x27A
Nominal Grid Voltage(额定电网电压):	3/N/PE, 230/400V~
Max. Output Current(最大输出电流):	3x25A
Nominal Grid Frequency(额定电网频率):	50Hz
Max. Output power(最大输出功率):	17000VA
Power factor(功率因数):	>0.99(adjustable+/-0.8)
Ingress protection(IP等级):	IP65
Operating Temperature Range(运行环境温度):	-25~+60°C
Protective Class(保护级别):	Class I
Made in China(中国制造)	

Manufacturer: Shenzhen SOFARSOLAR Co., Ltd.
制造商: 深圳市首航新能源有限公司
SAA140078
VDE0126-1-1, VDE-AR-N4105, G59/3, IEC61727, IEC62116, C10/11, RD1699, UTE C15-712-1, AS4777



SOFAR SOLAR Solar Inverter
光伏并网逆变器

Sofar 20000TL-Sx Series

Max. DC input voltage(最大直流输入电压):	1000V
Operating MPPT voltage range(MPPT电压范围):	250-960V
Max. Input current(最大输入电流):	2x24A
Max. PV Isc(最大输入短路电流):	2x30A
Nominal Grid Voltage(额定电网电压):	3/N/PE, 230/400V~
Max. Output Current(最大输出电流):	3x29A
Nominal Grid Frequency(额定电网频率):	50Hz
Max. Output power(最大输出功率):	20000VA
Power factor(功率因数):	>0.99(adjustable+/-0.8)
Ingress protection(IP等级):	IP65
Operating Temperature Range(运行环境温度):	-25~+60°C
Protective Class(保护级别):	Class I
Made in China(中国制造)	

Manufacturer: Shenzhen SOFARSOLAR Co., Ltd.
制造商: 深圳市首航新能源有限公司
SAA140078
VDE0126-1-1, VDE-AR-N4105, G59/3, IEC61727, IEC62116, C10/11, RD1699, UTE C15-712-1, AS4777



DRM0	<input checked="" type="checkbox"/>	DRM1	<input type="checkbox"/>	DRM2	<input type="checkbox"/>
DRM3	<input type="checkbox"/>	DRM4	<input type="checkbox"/>	DRM5	<input type="checkbox"/>
DRM6	<input type="checkbox"/>	DRM7	<input type="checkbox"/>	DRM8	<input type="checkbox"/>

General product information:

The Solar Inverter converts DC voltage into AC voltage.

The input and output are protected by Varistors to Earth. The unit is providing EMC filtering at the output toward mains. The unit does not provide galvanic separation from input to output (transformerless). The output is switched off redundant by the high power switching bridge and a two relays. This assures that the opening of the output circuit will also operate in case of one error.

Description of the electrical circuit:

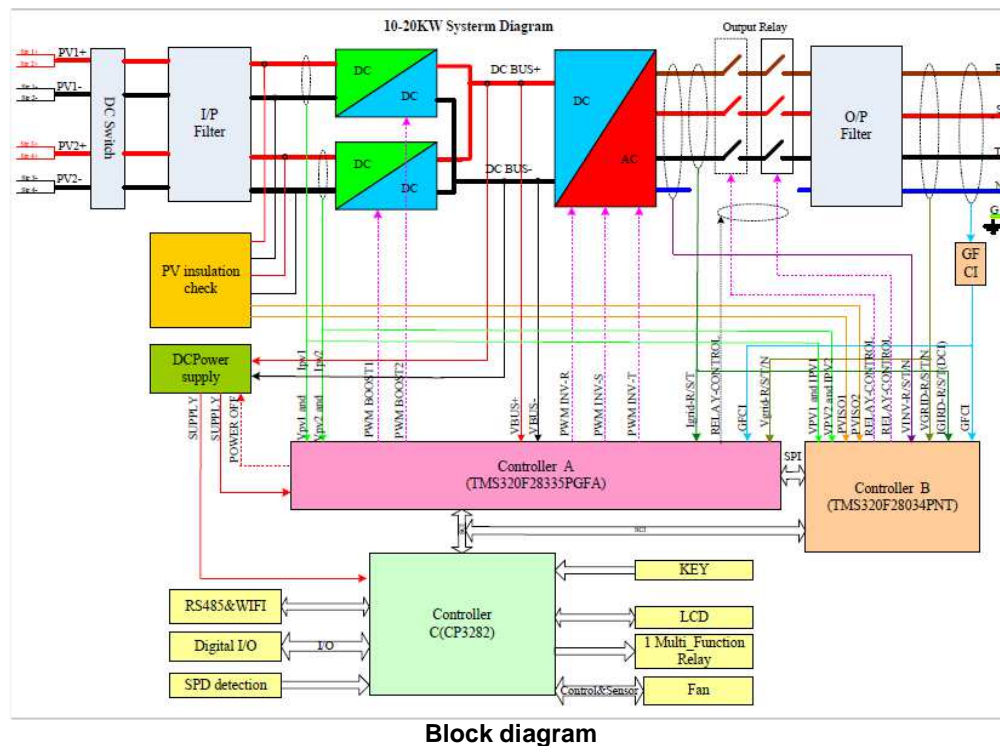

The internal control is redundant built. It consists of Microcontroller Controller A (UC20) and Controller B (UC73).

The Controller A (UC20) control the relays (RLB1-RLB6) by switching signals; measures the PV voltage, PV current, Bus voltage, grid voltage, frequency, AC current with injected DC and the array insulation resistance to ground. In addition it tests the current sensors and the RCMU circuit before each start up.

The Controller B (UC73) is measures the grid voltage, AC current, grid frequency and residual current, also can switch off the relays (RLB1-RLB6) independently, and communicate with Controller A (UC20) each other.

The current is measured by a current sensor. The AC current signal and the injected DC current signal are sent to the Master DSP. The Master DSP tests and calibrates before each start up all current sensors.

The unit provides two relays in series in all output conductors. When single fault applied to one relay, alarm an error code in display panel, another redundant relay provides basic insulation maintained between the PV array and the mains. All the relays are tested before each start up.

Differences of the models:

The models SOFAR 10000TL-Sx Series, SOFAR 15000TL-Sx Series, SOFAR 17000TL-Sx Series and SOFAR 20000TL-Sx Series are same as in hardware except the components are in the difference table. Identical in software the output power just adjusted by software.

Difference table				
	Sofar10000TL-Sx Serie	Sofar15000TL-Sx Serie	Sofar17000TL-Sx Serie	Sofar20000TL-Sx Serie
Input sample resistance of current: REA71, REA73, REA79, REA81	10Kohm/1/10W/F/0603	13Kohm/1/10W/F/0603	13Kohm/1/10W/F/0603	15Kohm/1/10W/F/0603
Output sample resistance of current: RB46, RB52, RB58, RB79, RB81, RB95	1.5Kohm/1/10W/F/0603	2Kohm/1/10W/F/0603	2Kohm/1/10W/F/0603	2.7Kohm/1/10W/F/0603
Output sample resistance of current: RB47, RB53, RB59, RB80, RB82, RB96	30ohm/1/10W/F/0603	30ohm/1/10W/F/0603	330ohm/1/10W/F/0603	30ohm/1/10W/F/0603
Full BUS Capacitor: CA129, CA131, CA145, CA148	2pcs (CA129, CA145, CA131, CA145, CA148) (25UF/1100V/57.5*35*50)	3pcs (CA129, CA145, CA148) (25UF/1100V/57.5*35*50)	4pcs (CA129, CA131, CA145, CA148) (25UF/1100V/57.5*35*50)	4pcs (CA129, CA131, CA145, CA148) (25UF/1100V/57.5*35*50)
Half BUS Capacitor: CD1, CD2, CD3, CD4, CD5, CD6, CD7, CD8, CD39, CD40	4pcs (CD1, CD2, CD3, CD4) (75UF/700Vdc/57.5*35*50)	6pcs (CD1, CD2, CD3, CD4, CD5, CD6) (75UF/700Vdc/57.5*35*50)	8pcs (CD1, CD2, CD3, CD4, CD5, CD6, CD7, CD8) (75UF/700Vdc/57.5*35*50)	10pcs (CD1, CD2, CD3, CD4, CD5, CD6, CD7, CD8, CD39, CD40) (75UF/700Vdc/57.5*35*50)
IGBT module: QD1, QD2, QD3	FZ12NMA040SH-M267F	FZ12NMA040SH-M267F	10-FZ12NMA080SH01-M260F	10-FZ12NMA080SH01-M260F
Boosting diode	2pcs (DA20, DA25, SC S220KE2)	4pcs (DA19, DA20, DA24, DA25, SCS220KE2)	4pcs (DA19, DA20, DA24, DA25, SCS220KE2)	4pcs (DA19, DA20, DA24, DA25, SCS220KE2)
Boosting IGBT: QA19, QA20, QA28, QA29	2pcs FGH40T120SMD-F155 (QA20, QA28, QA29)	4pcs FGH40T120SMD-F155 (QA19, QA20, QA28, QA29)	4pcs FGY40T120SMD (QA19, QA20, QA28, QA29)	4pcs FGY40T120SMD (QA19, QA20, QA28, QA29)
Boosting conductor	2pcs 10KW Boost/MS226060-2*4/2.7mH+/-10/90mΩ MAX/P7&P12	2pcs 15KW/17KW BOOST/2100uH/AMCC80/φ2.1*3P/21A/CUT-80	2pcs 15KW/17KW BOOST/2100uH/AMCC80/φ2.1*3P/21A/CUT-80	2pcs 20KW BOOST/1.8mH±10%/AMCC80/CUT-80
INT conductor	3pcs 10KW INV/MS226060-2*4/1.38mH+/-10/47mΩ MAX/P1/R	3pcs 15KW 960uH/AMCC63/φ2.1*3P/22A/CUT-63	3pcs 17KW 850uH/AMCC80/φ2.3*3P/25A/CUT-80	3pcs 20KW 0.73mH±10%/AMCC80/CUT-80
internal fan	without	with	with	with

Model difference table			
		AC SPD	DC SPD
Sofar10000TL Sx;			
Sofar15000TL Sx;	x=2	with out	with out
Sofar17000TL Sx;	x=4	with out	contain
Sofar20000TL Sx;	x=5	contain	contain

The product was tested on:

Hardware Version: V2.0

Software Version: V3.0

AS/NZS 4777.2 – 2015			
Clause	Requirement – Test	Result - Remark	Verdict
5	GENERAL REQUIREMENTS		P
5.1	Electrical safety		P
	Inverters for use in inverter energy systems with photovoltaic (PV) arrays shall comply with the appropriate electrical safety requirements of IEC 62109-1 and IEC 62109-2, and the requirements within this Standard.	An applicable test report according to IEC 62109-1, IEC 62109-2 must be provided by the manufacturer.	P
	Inverters for use in inverter energy systems that have energy storage (batteries) as the only possible energy source shall comply with the electrical safety requirements of AS 62040.1.1, and the requirements within this Standard.	No such the energy storage system.	N/A
	Inverters for use in inverter energy systems that incorporate energy sources other than photovoltaic (PV) arrays or batteries shall comply with the applicable electrical safety requirements of IEC 62109-1 and IEC 62109-2, and the requirements within this Standard.	An applicable test report according to IEC 62109-1, IEC 62109-2 must be provided by the manufacturer.	P
5.2	Provision for external connections	Provided in the installation manual.	P
	Inverters shall be used and installed as fixed equipment only.		P
	Inverter provisions for external connection -	See below.	P
	(a) shall be for fixed equipment only; and	Complied.	P
	(b) shall provide for safe and reliable connection to any d.c. source or load or any a.c. source or load.	Provided in the installation manual.	P
	All inverter ports (except communications ports) shall incorporate connection types for either -	See below.	P
	(i) permanently connected equipment; or		P
	(ii) pluggable type B equipment.	Permanently connected equipment	N/A
	Inverter source or load connections shall not incorporate connection types for pluggable type A equipment.		P
	Permanently connected inverters shall have suitable terminals for connection to fixed installation wiring.	Complied.	P
	Pluggable type B equipment shall have one of the following means of connection:	Permanently connected equipment	N/A
	(A) A non-detachable cord for connection to the supply by means of a connector.	Permanently connected equipment	N/A

	(B) An appliance inlet suitable for connection to a matching connector.	Permanently connected equipment	N/A
	Pluggable type B equipment shall not incorporate -	See below.	N/A
	(1) a connection by a connector or inlet complying with any of the dimensional sheets of AS/NZS 60320.1;		N/A
	(2) a connection by a plug conforming to AS/NZS 3112; or	No such plug used.	N/A
	(3) a connection by a connector or inlet where hazardous voltages are accessible by the standard test finger.	No such devices..	N/A
5.3	Photovoltaic (PV) array earth fault/earth leakage detection		P
	For inverter energy systems used with PV array systems that require earth fault detection and a residual current detection, either internal or external to the inverter, the type of detection used shall be declared in accordance with IEC 62109-1 and IEC 62109-2.	An applicable test report according to IEC 62109-1, IEC 62109-2 must be provided by the manufacturer.	P
	If an external residual current device (RCD) is required, the manufacturer's installation instructions shall state the need for an RCD and shall specify its rating, type and required circuit location in accordance with Clause 9.		N/A
	Where the additional detection for functionally earthed PV arrays, as required by AS/NZS 5033, is present in the inverter, this additional detection shall, before start-up of the system -	See below.	P
	(a) open circuit the functional earth connection to the PV array;		P
	(b) measure the resistance to earth of each conductor of the PV array;	An applicable test report according to IEC 62109-1, IEC 62109-2 must be provided by the manufacturer.	P
	(c) if the earth resistance is above the resistance limit (Riso limit) threshold specified in Table 1, the system shall reconnect the functional earth and shall be allowed to start; and	An applicable test report according to IEC 62109-1, IEC 62109-2 must be provided by the manufacturer.	P
	(d) if the earth resistance is equal to or less than the resistance limit (Riso limit) threshold specified in Table 1, the inverter shall shut down and initiate an earth fault alarm in accordance with the requirements of IEC 62109-2.	An applicable test report according to IEC 62109-1, IEC 62109-2 must be provided by the manufacturer.	P
5.4	Compatibility with electrical installation		P
	The inverter shall be compatible with wiring practices for LV electrical	Considered.	P

	installations of AS/NZS 3000 and variations as required in AS/NZS 4777.1. The inverter a.c. voltage and frequency operation shall comply with the limits specified in AS 60038 (for Australia), or IEC 60038 (for New Zealand).		
5.5	Power factor		P
	The displacement power factor of the inverter, considered as a load from the perspective of the grid, shall, for all current outputs from 25% to 100% of rated current, operate at unity power factor within the range 0.95 leading to 0.95 lagging.	See appendix table.	P
	Operation at power factor other than unity is acceptable where the inverter operates in power quality response modes.	See Clause 6.3.	P
5.6	Harmonic currents		P
	The harmonic currents of the inverter shall not exceed the limits specified in Tables 2 and 3 and the total harmonic current distortion (ITHD) to the 50th harmonic shall be less than 5%.	See appendix table 5.6 Harmonic currents.	P
5.7	Voltage fluctuations and flicker		P
	The inverter shall conform to the voltage fluctuation and flicker limits specified in AS/NZS 61000.3.3 for equipment with rated current less than or equal to 16 A per phase (a.c.).	See appendix table 5.7 Voltage Fluctuations and Flicker.	P
	For equipment with rated current greater than 16 A per phase (a.c.), The impedance shall be determined in accordance with the methods given in AS/NZS 61000.3.11.	See appendix table 5.7 Voltage Fluctuations and Flicker.	P
5.8	Transient voltage limits		P
	To prevent damage to electrical equipment connected to the same circuit as the inverter, disconnection of the inverter from the grid shall not result in transient overvoltages beyond the limits specified in Table 4.	See appendix table 5.8 Transient Voltage Limits (phase to neutral).	P
5.9	D.C. current injection		P
	In the case of a single-phase inverter, the d.c. output current of the inverter at any a.c. port including the grid-interactive and/or stand-alone port shall not exceed 0.5% of the inverter's rated current or 5 mA, whichever is the greater.	See appendix table 5.9 Direct current injection.	P
	In the case of a three-phase inverter, the d.c. output current of the inverter at any	This is three-phase grid inverter.	P

	a.c. port, including the grid-interactive and/or stand-alone port, measured in each of the phases, shall not exceed 0.5% of the inverter's per-phase rated current or 5 mA, whichever is the greater.		
5.10	Current balance for three-phase inverters		P
	In the case of a three-phase inverter the a.c. output current shall be generated and injected into the three-phase electrical installation as a three-phase balanced current.	See appendix table 5.10.	P

6	OPERATIONAL MODES AND MULTIPLE MODE INVERTERS		P
6.1	General		P
	Unless otherwise stated, the modes in the following Clauses are for the grid-interactive port of the inverter.		P
6.2	Inverter demand response modes (DRMs)		P
6.2.1	General	See below.	P
	The inverter shall support the demand response mode DRM 0 of Table 5. The inverter should support the other demand response modes of Table 5.	See appendix table 6.2.	P
	The inverter shall detect and initiate a response to all supported demand response commands within 2 s. The inverter shall continue to respond while the mode remains asserted.	See appendix table 6.2.	P
6.2.2	Interaction with demand response enabling device (DRED)	See below.	P
	The inverter shall have a means of connecting to a DRED. This means of connection shall include a terminal block or RJ45 socket.	Considered.	P
	The terminal block or RJ45 socket shall comply with the minimum electrical specifications in Table 6.	Considered.	P
	The DRED asserts demand response modes by shorting together terminals or pins as specified in Table 7.	Considered.	P
6.3	Inverter power quality response modes		P
6.3.1	General	See below.	P
	The inverter may have the capability of operating in modes which will -		P
	(a) contribute to maintaining the power quality at the point of connection with the customer installation; or		P
	(b) provide characteristics which are		P

	outside the typical operation of an inverter for the purpose of providing support to a grid.		
6.3.2	Volt response modes		P
6.3.2.1	General	See below.	P
	The intent of including the volt response modes, which respond to voltage changes at the inverter terminals, is to increase the number of systems which can be connected at a point on the grid without adversely affecting the voltage within an electrical installation.		P
	The volt-watt and volt-var response modes specified in Clause 6.3.2.2 and Clause 6.3.2.3 shall use the volt response reference values specified in Table 9.		P
6.3.2.2	Volt-watt response mode		P
	The inverter should have the volt-watt response mode. If this mode is available, it shall be enabled by default.		P
	The response curve required for the volt-watt response mode is defined by the volt response reference values in Table 9 and corresponding power levels. The default values are listed in Table 10 and example response modes are shown in Figure 2(A) for Australia and Figure 2(B) for New Zealand.	See appendix table 6.3.2.2.	P
6.3.2.3	Volt-var response mode		N/A
	The inverter should have the volt-var response capability. If this mode is available, it shall be disabled by default.		N/A
	The response curve required for the volt-var response is defined by the volt response reference values specified in Table 9 and corresponding var levels. The default values are listed in Table 11 and shown in Figure 3.	See appendix table.	N/A
6.3.2.4	Voltage balance modes		P
	Three-phase inverters, or single-phase inverters used in a three-phase combination may be used for voltage balancing between phases by injecting unbalanced three-phase currents into the electrical installation.	Considered.	P
	If the voltage balance mode is available, the following requirements apply:	see below.	P
	(a) The voltage balance mode shall be disabled by default.		N/A
	(b) For single-phase inverters used in a	The EUT is three-phase type.	N/A

	three-phase combination, the requirements of Clause 8.2 apply.		
	(c) The voltage balancing mode shall be able to -	See below.	P
	(i) operate correctly with a single fault applied;		P
	(ii) detect the fault or loss of operability and cause the inverter to revert to injecting current into the three-phase electrical installation as a three-phase balanced current; or		P
	(iii) detect the fault or loss of operability and disconnect the inverter from the electrical installation.		P
6.3.3	Fixed power factor mode and reactive power mode		P
	These modes shall be disabled by default.		P
	If the inverter is capable of operating with reactive power mode, the maximum ratio of reactive power (vars) to rated apparent power should be 100%.	See appendix table 6.3.3.	P
	If the inverter is capable of operating with fixed power factor mode, the minimum range of settings should be 0.8 leading to 0.8 lagging.	See appendix table 6.3.3.	P
6.3.4	Characteristic power factor curve for $\cos \varphi$ (P) (Power response)		P
	If this mode is available, it shall be disabled by default.		P
	The response curve required for the $\cos \varphi$ (P) response should be defined within displacement power factor range of 0.9 leading to 0.9 lagging. One possible $\cos \varphi$ (P) curve is shown in Figure 4.	See appendix table 6.3.4.	P
6.3.5	Power rate limit		P
6.3.5.1	General	See below.	P
	The power rate limit for an inverter is a power quality response mode.		P
	The inverter shall have the capability to rate limit changes in power generation through the grid-interactive port.		P
	Inverters capable of multiple mode operation should have the capability to rate limit changes in power consumption (for example increasing/decreasing of charging rates of connected energy storage).		N/A
	The power rate limit does not apply when the inverter disconnection device is		P

	required to operate (i.e. to disconnect).		
6.3.5.2	Gradient of power rate limit		P
	The default setting for the power rate limit (WGra) for increase and decrease shall be 16.67% of rated power per minute which is a nominal ramp time of 6 min.	See appendix table 6.3.5.	P
	The power rate limit (WGra) shall be adjustable within the range 5% to 100% of rated power per minute.	See appendix table 6.3.5.	P
	It is acceptable to have two separate power rate limits for increase and decrease in output power, as follows:		N/A
	(a) To rate limit an increase in power (WGra+).	Considered.	P
	(b) To rate limit a decrease in power (WGra-).		N/A
6.3.5.3	Power rate limit modes		P
6.3.5.3.1	General		P
	The inverter power rate limit (WGra) is applicable to operate in the following modes:		P
6.3.5.3.2	Soft ramp up after connect or reconnect		P
	All inverters shall have this mode. This mode shall be enabled as per Clause 7.7 and for the increase in power required by Clause 7.5.3 after frequency decreased to the required limit.	See appendix table.	P
6.3.5.3.3	Changes in a.c. operation and control	No such function.	N/A
	If available, this mode shall be enabled for a change in a demand response mode of Clause 6.2 (except for DRM 0).		N/A
	The power rate limit for changes in a.c. operation and control does not apply to those inverters that are correcting for sags and swells of less than 1 min.		N/A
6.3.5.3.4	Changes in energy source operation	No energy source in the EUT.	N/A
	This mode only applies to multiple mode inverters with energy storage. It operates when there is a change in the energy resource available to the inverter, which causes a change in output through the grid-interactive port.		N/A
	For this mode the power rate limit (WGra) should apply to the increase or decrease in power generation or consumption, and to the transitions between power output levels.		N/A
	For this mode, the power rate limit (WGra)		N/A

	should be able to be enabled or disabled.		
	The power rate limit shall be disabled by default.		N/A
	The increase or decrease for transitions between power output levels is contingent on external situations (such as amount of available solar energy, wind energy or discharge capacity).		N/A
	Only for increases or decreases in the output which are faster than the power rate limit (WGra) does a control action to limit the ramp rate apply.		N/A
6.3.5.4	Nonlinearity of power rate limit changes		P
	The nonlinearity (NL) of the power rate limit (WGra) in response to an increase of the inverter power output, as defined by the characteristic curve depicted in Figure 5, shall be less than 10%.		P
6.4	Multiple mode inverter operation	No multiple mode.	N/A
6.4.1	General	See below.	N/A
	When the multiple mode inverter is disconnected from the grid any stand-alone port shall ensure that all active conductors are also isolated from the grid-interactive port.		N/A
	Multiple mode inverters shall be arranged to ensure that the continuity of the neutral conductor to the load from the electrical installation is not interrupted when the inverter disconnects from the grid and supplies a load via the stand-alone port.		N/A
	When the multiple mode inverter is providing the stand-alone function and is disconnected from the grid, the stand-alone port shall comply with the requirements for d.c. current injection (refer to Clause 5.9) into the connected load circuits. The type of RCD compatible with and for use on the stand-alone function outputs shall be declared.		N/A
6.4.2	Sinusoidal output in stand-alone mode	The EUT is a Grid-tied inverter.	N/A
	The a.c. output voltage waveform of a stand-alone port of a multiple mode inverter operating in stand-alone mode, shall comply with the requirements of this Clause (6.4.2). The a.c. output voltage waveform of a stand-alone mode shall have a voltage total harmonic distortion (THD) not exceeding of 5% and no individual harmonic at a level exceeding 5%.		N/A

6.4.3	Volt-watt response mode for charging of energy storage	No energy storage system in the EUT.	N/A
	A multiple mode inverter with energy storage which can be charged from the grid shall have this volt-watt response mode.		N/A
	This volt-watt response mode is only active when power from the grid is required to charge the energy storage.		N/A
	The response curve required for the volt-watt response is defined by the volt response reference values in Table 9 and corresponding power consumption from the grid through the grid-interactive port for charging energy storage. The default values are listed in Table 12 and shown in Figure 6.		N/A
6.5	Security of operational settings		P
	The internal settings of the demand response or power quality response modes of the inverter shall be secured against inadvertent or unauthorized tampering.	Considered.	P
	Changes to the internal settings shall require the use of a tool and special instructions not provided to unauthorized personnel.	Provide in installation manual.	P

7	PROTECTIVE FUNCTIONS FOR CONNECTION TO ELECTRICAL INSTALLATIONS AND THE GRID		P
7.1	General	See below.	P
	The automatic disconnection device shall operate -	The automatic disconnection device is integral part of the inverter.	P
	(a) if supply from the grid is disrupted;	Considered.	P
	(b) when the grid goes outside preset parameters (e.g. undervoltage/overvoltage, under-frequency/over-frequency); or	Considered.	P
	(c) when the demand response mode DRM 0 (see Clause 6.2) is asserted.	Considered.	P
	For inverter energy systems connected to multiple phases the automatic disconnection device shall operate if any of the above conditions is met on any phase.	Considered.	P
7.2	Automatic disconnection device		P
	The automatic disconnection device shall provide isolation in all live conductors	The unit is switched off redundant by the high power bridge of the inverter and the relays in line and	P

		neutral.	
	The automatic disconnection device shall be capable of interrupting at least the rated current.	Considered.	P
	The settings of the automatic disconnection device shall not exceed the capability of the inverter.	Considered.	P
	A semiconductor (solid-state) device shall not be used for isolation purposes.	Considered.	P
7.3	Active anti-islanding protection	See below.	P
	The automatic disconnection device shall incorporate at least one method of active anti-islanding protection.	Considered.	P
	The method used to provide active anti-islanding protection shall be declared.	Rate of change of frequency (RoCof) detection method used.	P
	To prevent islanding, the active anti-islanding protection system shall operate the automatic disconnection device (see Clause 7.2) within 2 s of disruption to the power supply from the grid.	See appendix table . 7.3.	P
	Compliance shall be determined by type testing in accordance with the active anti-islanding tests specified in Appendix F or IEC 62116.	Considered.	P
7.4	Voltage and frequency limits (passive anti-islanding protection)	See below.	P
	The automatic disconnection device shall incorporate the following forms of passive anti-islanding protection:	Considered.	P
	(a) Undervoltage and overvoltage protection.	See appendix table 7.4	P
	(b) Under-frequency and over-frequency protection.	See appendix table 7.4	P
7.5	Limits for sustained operation		P
7.5.1	General	See below.	P
	The inverter or inverter energy system shall remain connected over the range of voltages and frequencies that it is required to be compatible with. Refer to Clause 5.4.	Considered.	P
7.5.2	Sustained operation for voltage variations		P
	The inverter shall operate the automatic disconnection device (see Clause 7.2) within 3 s when the average voltage for a 10 min period exceeds the V_{nom_max} , where V_{nom_max} lies in the range 244–258 V.	See appendix table 7.5.2	P

	The default set-point for Vnom-max shall be as follows: (a) In Australia: 255 V. (b) In New Zealand: 248 V.	See appendix table 7.5.2	P
7.5.3	Sustained operation for frequency variations		P
7.5.3.1	Response to an increase in frequency		P
	The inverter shall be capable of supplying rated power between 47 Hz and 50.25 Hz for Australia.	Considered.	P
	The inverter shall be capable of supplying rated power between 45 Hz and 50.25 Hz for New Zealand.		N/A
	The power level present at the time the frequency reaches or exceeds 50.25 Hz shall be held as the reference power level used to calculate the required response to the increasing frequency.	Considered.	P
	This is expressed in the equation below: $P_{out} = P_{ref} \left[1 - \frac{(f - 50.25)}{(f_{stop} - 50.25)} \right]$ where P _{out} = required output for a frequency between 50.25 Hz and f _{stop} P _{ref} = reference power level when the frequency reaches or exceeds 50.25 Hz f = frequency between 50.25 Hz and f _{stop} When the frequency exceeds f _{stop} the inverter power output shall be ceased (i.e. 0 W). The default set-point for f _{stop} shall be 52 Hz.	See appendix table 7.5.3.1	P
	Unconstrained power operation may recommence 6 min after the frequency returns to and remains at less than 50.15 Hz.	See appendix table 7.5.3.1	P
7.5.3.2	Response to a decrease in grid frequency	The EUT without energy storage.	N/A
	This requirement applies only to inverters with energy storage.		N/A
	The inverter shall be capable of charging the energy storage between 49.75 Hz and 52.0 Hz.		N/A
	The power input level for charging present at the time the frequency reaches or falls below 49.75 Hz shall be held as the reference charge rate used to calculate the required response to the decreasing		N/A

	frequency.		
	<p>This is expressed in the equation below:</p> $P_{\text{charge}} = P_{\text{ref}} \left[1 - \frac{(49.75 - f)}{(49.75 - f_{\text{stop-CH}})} \right]$ <p>where</p> <p>P_{charge} = charge rate of the storage element for a frequency between 49.75 Hz and $f_{\text{stop-CH}}$</p> <p>$P_{\text{ref-CH}}$ = charge rate of the storage element when the frequency reaches or falls below 49.75 Hz</p> <p>f = frequency between 49.75 Hz and $f_{\text{stop-CH}}$</p> <p>When the frequency falls below $f_{\text{stop-CH}}$, the inverter should have ceased charging the storage element (i.e. 0 W). The default set-point for $f_{\text{stop-CH}}$ should be 49 Hz.</p>		N/A
	Unconstrained charging of the storage element may recommence 6 min after the frequency returns to and remains above than 49.85 Hz.		N/A
7.6	Disconnection on external signal	See below	P
	The automatic disconnection device shall incorporate the ability to disconnect on an external signal.	The automatic disconnection device is integral part of the inverter.	P
	If an external signal or demand response 'DRM 0' condition is asserted, the automatic disconnection device shall operate within 2 s.	Considered.	P
7.7	Connection and reconnection procedure	See below	P
	Only after all of the following conditions have been met shall the automatic disconnection device operate to connect or reconnect the inverter to the grid -	The unit provides monitoring of the voltage, frequency and synchronisation. If one of these conditions is not met, then the unit is not switching on.	P
	(a) the voltage of the grid has been maintained within the limits of AS 60038 (for Australia) or IEC 60038 (for New Zealand) for at least 60 s;	Considered.	P
	(b) the frequency of the grid has been maintained within the range 47.5 Hz to 50.15 Hz for at least 60 s;	Considered.	P
	(c) the inverter and the grid are synchronized and in-phase with each other; and	Considered.	P
	(d) no external signal is present or DRM 0 asserted requiring the system to be disconnected.	Considered.	P

7.8	Security of protection settings		P
	The internal settings of the automatic disconnection device shall be secured against inadvertent or unauthorized tampering. Changes to the internal settings shall require the use of a tool and special instructions not provided to unauthorized personnel.	Changes to the internal settings shall require the use of a tool and special instructions provided to authorized personnel.	P

8	MULTIPLE INVERTER COMBINATIONS		N/A
8.1	General	See below.	N/A
	If a combination is not tested, it should not be used or external devices should be used in accordance with the requirements of AS/NZS 4777.1.	This is a three-phase grid inverter, and it's not used for parallel installations.	N/A
	Possible combinations are single-phase inverters used in parallel, single-phase inverters used in multiple phase installations and three-phase inverters used in parallel.	This is a three-phase grid inverter, and it's not used for parallel installations.	N/A
8.2	Inverter current balance across multiple phases	This is a three-phase grid inverter, and it's not used for parallel installations.	N/A
	The maximum current imbalance in a three-phase inverter system comprised of individual single-phase inverters shall be no more than 21.7 A.	This is a three-phase grid inverter, and it's not used for parallel installations.	N/A
8.3	Grid disconnection		N/A
	When any inverter within the inverter energy system disconnects as required by Clause 7, all inverters within the inverter energy system shall disconnect within 2 s of the first inverter disconnecting.	No energy system in the EUT.	N/A
	This applies to all inverters used in combination for single-phase or multiple phases.	This is a three-phase grid inverter.	N/A
8.4	Grid connection and reconnection	No such installation.	N/A
	When multiple inverters are used together in a multiple phase combination, only after all the conditions of Clause 7.7 have been met on all connected phases shall the automatic disconnection device operate to connect or reconnect any inverter of the multiple phase combination to the grid.		N/A
	Where any inverter used in a multiple phase combination has a rated current exceeding 21.7 A per phase, the requirement of Clause 8.2 shall be met when connecting or reconnecting.		N/A

8.5	Testing combinations		N/A
8.5.1	Single-phase combinations	This is a three-phase grid inverter.	N/A
	Single-phase parallel combinations of inverters shall be tested for combinations with total rated current (I_{rated}) equal to or up to the maximum of 6 A per phase.	This is a three-phase grid inverter.	N/A
	To determine the number of inverters to be tested, the following equation shall be used: $N = \frac{6}{I_{rated}}$ <p>where N = number to be tested, rounded up to next whole number I_{rated} = rating of the inverter in amperes</p> <p>If $N \geq 2$, the minimum number of inverters to be tested shall be N. If $N > 6$, the maximum number of inverters to be tested in a combination shall be 6.</p>	This is a three-phase grid inverter.	N/A
8.5.2	Single-phase inverters used in three-phase combinations	This is a three-phase grid inverter.	N/A
	For single-phase inverters with rated current (I_{rated}) greater than or equal to 5 A used in three-phase combinations, three inverters shall be tested in a three-phase arrangement [refer to Figure 8(a)].	This is a three-phase grid inverter.	N/A
	Single-phase inverters with rated current less than 5 A and to be used in three-phase combinations shall be tested in combination with at least two inverters per phase [refer to Figure 8(b)].	This is a three-phase grid inverter.	N/A
8.5.3	Required tests for multiple inverter combinations	This is a three-phase grid inverter.	N/A
	Any single-phase inverter used in a multiple inverter combination shall be tested individually and meet all the requirements of this Standard. Any single-phase inverter which is to be used as part of a multiple inverter combination shall be tested in combination as specified in Clauses 8.5.1 and 8.5.2.	This is a three-phase grid inverter.	N/A
8.5.4	Multiple inverters with one automatic disconnection device	This is a three-phase grid inverter, and it's not used for parallel installations.	N/A
	Where the inverter does not have an internal automatic disconnection device, or requires an external automatic disconnection device to provide the required disconnection function, or both,	This is a three-phase grid inverter, and it's not used for parallel installations.	N/A

	testing shall be conducted with the automatic disconnection device and with either the number of inverters required by Clause 8.5.1 and 8.5.2 or with the automatic disconnection device configured with the number of inverters specified by the manufacturer's instructions.		
--	--	--	--

9	INVERTER MARKING AND DOCUMENTATION		P
9.1	General		P
	All markings and documentation shall be in the English language.	Considered.	P
9.2	Marking		P
9.2.1	General		P
9.2.2	Equipment ratings		P
	Photovoltaic		-
	Vmax PV (absolute maximum)	1000V	P
	Isc PV (absolute maximum)	2x20A for SOFAR 10000TL; 2x27A for SOFAR 15000TL, SOFAR 17000TL; 2x30A for SOFAR 20000TL;	P
	Wind (a.c. or d.c.)		-
	Voltage (nominal or range)		N/A
	Rated current (maximum continuous)		N/A
	Frequency (nominal or range) (a.c. wind only)		N/A
	Energy storage ports		-
	Voltage (nominal)		N/A
	Voltage (range)		N/A
	Rated current (maximum continuous)		N/A
	Storage type		N/A
	Other energy sources or inputs (a.c. or d.c.)		-
	Voltage (nominal or range)		N/A
	Rated current (maximum continuous)		N/A
	Power factor (range)		N/A
	Frequency (nominal or range) (a.c. sources only)		N/A
	a.c. output ratings (for each port)		-
	Voltage (nominal or range)	3/N/PE, 230/400Vac	
	Rated current	3x15,0A for SOFAR 10000TL; 3x22,0A for SOFAR 15000TL;	P

		3x25,0A for SOFAR 17000TL; 3x29,0A for SOFAR 20000TL;	
	Frequency (nominal or range)	50,00Hz	P
	Rated apparent power	10000VA for SOFAR 10000TL; 15000VA for SOFAR 15000TL; 17000VA for SOFAR 17000TL; 20000VA for SOFAR 20000TL;	P
	Power factor range	1,0(adjustable+/-0,8)	P
	d.c. output ratings		-
	Voltage (nominal or range)		N/A
	Rated current		N/A
	Inverter topology	Non-isolated.	P
	Protective class (I, II or III)	Class I	P
	Ingress protection (IP) rating	IP65	P
9.2.3	Ports		P
	Each port shall be marked with its classification and indicate whether a.c or d.c. voltage as appropriate.	The classification marking were provided adjacent to the terminals of each port.	P
9.2.4	External and ancillary equipment	Ref to installation manual.	P
9.2.5	Residual current devices (RCDs)		N/A
	Where an external RCD is required, the inverter shall be marked with a warning along with the rating and type of RCD required. The warning shall be located in a prominent position and written in lettering at least 5 mm high. It shall contain the following or an equivalent statement: WARNING: AN RCD IS REQUIRED ON THE [NAME] PORTS OF THE INVERTER	The Residual current devices (RCDs) are integral part of inverter. An applicable test report according to IEC 62109-1, IEC 62109-2 must be provided by the manufacturer.	N/A
	If the inverter energy system requires a Type B RCD, the inverter shall be marked with a warning. The warning shall be located in a prominent position and written in lettering at least 5 mm high. It shall contain the following: WARNING: A TYPE B RCD IS REQUIRED ON THE [NAME] PORTS OF THE INVERTER	The Residual current devices (RCDs) are integral part of inverter. An applicable test report according to IEC 62109-1, IEC 62109-2 must be provided by the manufacturer.	N/A
9.2.6	Demand response modes		P
	The demand response modes supported by the inverter should be permanently marked on the name plate or on a durable sticker located on or near the demand	The demand response modes supported by the inverter has permanently marked on the name plate closed the communication	P

	response interface port to indicate the demand response modes of which the unit is capable.	terminals for DRED.	
9.3	Documentation		P
9.3.1	General		P
9.3.2	Equipment ratings		P
	Photovoltaic		-
	Vmax PV (absolute maximum)	1000V	P
	PV input operating voltage range	250-960Vdc	P
	Maximum operating PV input current	2x15,0A for SOFAR 10000TL; 2x21,0A for SOFAR 15000TL, SOFAR 17000TL; 2x24,0A for SOFAR 20000TL;	P
	Isc PV (absolute maximum)	2x20A for SOFAR 10000TL; 2x27A for SOFAR 15000TL, SOFAR 17000TL; 2x30A for SOFAR 20000TL;	P
	Maximum inverter backfeed current to array	No backfeed current to array.	P
	Wind (a.c. or d.c.)		-
	Voltage (nominal or range)		N/A
	Rated current (maximum continuous)		N/A
	Current (inrush)		N/A
	Frequency (nominal or range) (a.c. wind only)		N/A
	Energy storage ports		-
	Voltage (nominal or range)		N/A
	Nominal battery voltage		N/A
	Rated current (maximum continuous) input and output		N/A
	Storage type		N/A
	Other energy sources or inputs (a.c. or d.c.)		-
	Voltage (nominal or range)		N/A
	Rated current (maximum continuous)		N/A
	Power factor (range)		N/A
	Frequency (nominal or range) (a.c. sources only)		N/A
	a.c. output ratings (for each port)		-
	Voltage (nominal or range)	3/N/PE, 230/400Vac	P
	Rated current	3x15,0A for SOFAR 10000TL; 3x22,0A for SOFAR 15000TL;	P

		3x25,0A for SOFAR 17000TL; 3x29,0A for SOFAR 20000TL;	
	Current (inrush)	0,8A/2us	P
	Frequency (nominal or range)	50,00Hz	P
	Rated apparent power	10000VA for SOFAR 10000TL; 15000VA for SOFAR 15000TL; 17000VA for SOFAR 17000TL; 20000VA for SOFAR 20000TL;	P
	Power factor range	1,0(adjustable+/-0,8)	P
	Maximum output fault current	200A	P
	Maximum output overcurrent protection	3x15,0A for SOFAR 10000TL; 3x22,0A for SOFAR 15000TL; 3x25,0A for SOFAR 17000TL; 3x29,0A for SOFAR 20000TL;	P
	d.c. output ratings		-
	Voltage (nominal or range)		N/A
	Rated current		N/A
	Inverter topology	Non-isolated.	P
	Active anti-islanding method		P
	Protective class (I, II or III)	Class I	P
	Over voltage category	DC side: OVC II; AC side: OVC III	P
	Ingress protection (IP) rating	IP65	P
	Temperature operating range	-25° C ~ +60° C(above 45° C derating)	P
9.3.3	Ports		P
9.3.4	External and ancillary equipment	Provided in installation manual.	P
9.3.5	RCDs		P
9.3.6	Multiple mode inverters	No such mode.	N/A
9.3.7	Multiple inverter combinations	No such combinations.	N/A

APPENDIX A	GENERAL TEST AND REPORTING REQUIREMENTS (Normative)	P
-------------------	--	----------

APPENDIX B	POWER FACTOR TEST (Normative)	P
-------------------	--------------------------------------	----------

APPENDIX C	HARMONIC CURRENT LIMIT TEST (Normative)	P
-------------------	--	----------

APPENDIX	TRANSIENT VOLTAGE LIMIT TEST (Normative)	P
-----------------	---	----------

D		
APPENDIX E	D.C. INJECTION TEST (Normative)	P
APPENDIX F	ACTIVE ANTI-ISLANDING TEST (Normative)	P
APPENDIX G	VOLTAGE AND FREQUENCY LIMITS (PASSIVE ANTI-ISLANDING PROTECTION) TESTS (Normative)	P
APPENDIX H	LIMITS FOR SUSTAINED OPERATION (Normative)	P
APPENDIX I	DEMAND AND POWER QUALITY RESPONSE MODE TESTING INCLUDING DISCONNECTION ON EXTERNAL SIGNAL (Normative)	P
APPENDIX J	MULTIPLE INVERTER TESTING (Normative)	N/A
APPENDIX K	RELATED DOCUMENTS (Informative)	P

Test Results

5.5 Power factor Appendix B Power factor test						P
SOFAR 1000TL-Sx Series						
Mode	Measurement	Rated Output Current				
		15+/-5%	25+/-5%	50+/-5%	75+/-5%	100+/-5%
Unity	Vrms (V)	230,9	231,0	230,8	231,0	230,6
	Arms (A)	2,122	3,572	7,197	10,795	14,410
	Apparent Power (kVA)	1,469	2,475	4,983	7,480	9,970
	Power (kW)	1,468	2,475	4,983	7,480	9,970
	Recative power (kVar)	-0,052	-0,054	-0,054	-0,059	-0,060
	PF cos (phi)	0,999	1,000	1,000	1,000	1,000
Lag limit	Vrms (V)	230,1	230,2	230,3	230,1	229,8
	Arms (A)	2,398	4,020	8,030	12,039	16,047
	Apparent Power (kVA)	1,654	2,775	5,547	8,309	11,064
	Power (kW)	1,434	2,440	4,941	7,432	9,915
	Recative power (kVar)	0,824	1,323	2,522	3,716	4,910
	PF cos (phi)	0,887	0,899	0,891	0,894	0,896
Lead limit	Vrms (V)	229,9	229,9	229,9	230,0	229,8
	Arms (A)	2,233	3,843	7,864	11,874	15,885
	Apparent Power (kVA)	1,538	2,650	5,423	8,190	10,950
	Power (kW)	1,428	2,432	4,929	7,419	9,901
	Recative power (kVar)	-0,570	-1,053	-2,261	-3,470	-4,677
	PF cos (phi)	0,919	0,908	0,909	0,906	0,904
Modes	Vrms (V)	N/A	N/A	N/A	N/A	N/A
	Arms (A)	N/A	N/A	N/A	N/A	N/A
	Apparent Power (kVA)	N/A	N/A	N/A	N/A	N/A
	Power (kW)	N/A	N/A	N/A	N/A	N/A
	Recative power (kVar)	N/A	N/A	N/A	N/A	N/A
	PF cos (phi)	N/A	N/A	N/A	N/A	N/A

SOFAR 20000TL-Sx Series						
Mode	Measurement	Rated Output Current				
		15+/-5%	25+/-5%	50+/-5%	75+/-5%	100+/-5%
Unity	Vrms (V)	230,4	230,4	230,7	231,0	230,6
	Arms (A)	4,295	7,219	14,477	21,683	28,921
	Apparent Power (kVA)	2,968	4,989	10,019	15,027	20,011
	Power (kW)	2,967	4,988	10,019	15,027	20,011
	Reactive power (kVar)	0,103	0,099	0,084	0,060	0,029
	PF cos (phi)	0,999	1,000	1,000	1,000	1,000
Lag limit	Vrms (V)	230,6	230,4	229,9	229,7	230,1
	Arms (A)	4,737	7,893	15,765	23,601	29,587
	Apparent Power (kVA)	3,277	5,455	10,875	16,265	20,420
	Power (kW)	2,894	4,861	9,755	14,620	18,389
	Reactive power (kVar)	1,539	2,475	4,806	7,128	8,877
	PF cos (phi)	0,883	0,891	0,897	0,899	0,901
Lead limit	Vrms (V)	230,2	230,0	229,8	229,6	229,9
	Arms (A)	4,580	7,756	15,676	23,551	28,760
	Apparent Power (kVA)	3,163	5,351	10,805	16,223	19,838
	Power (kW)	2,892	4,859	9,760	14,628	17,856
	Reactive power (kVar)	-1,283	-2,242	-4,634	-7,015	-8,642
	PF cos (phi)	0,914	0,908	0,903	0,902	0,900
Modes	Vrms (V)	N/A	N/A	N/A	N/A	N/A
	Arms (A)	N/A	N/A	N/A	N/A	N/A
	Apparent Power (kVA)	N/A	N/A	N/A	N/A	N/A
	Power (kW)	N/A	N/A	N/A	N/A	N/A
	Reactive power (kVar)	N/A	N/A	N/A	N/A	N/A
	PF cos (phi)	N/A	N/A	N/A	N/A	N/A

Note:
 Inverter shall be connected to test circuit Figure B1 (AS/NZS 4777.2),
 The required accuracy for the measurement and reporting of results is ± 0.01 PF. The vars at the 15% test point are required to be the same or less than the vars at the 25% test point when operating at unity power factor.
 c: capacitive / leading
 i: inductive / lagging
 The tests had been performed on the SOFAR 10000TL-Sx Series and SOFAR 20000TL-Sx Series are valid for the SOFAR 15000TL-Sx Series and SOFAR 17000TL-Sx Series, since it is similar in hardware and just power derated by software.

5.6 Harmonic currents Appendix C Harmonic Current Limit Test							P
SOFAR 20000TL-Sx Series							
L1 phase							
Generating Unit rating per phase (rpp)							
	At 50% of rated output current			100% of rated output current A			
	Watts	3,323		Watts	6,647		
	VA	3,323		VA	6,647		
	Vrms	229,8		Vrms	230,3		
	Arms	14,462		Arms	28,857		
	PF	1,000		PF	1,000		
	Frequency	50,00		Frequency	50,00		
Harmonic	Value A	Angle degrees	% of fundamental	Value A	Angle degrees	% of fundamental	Limit in % of fundamental
0	N/A	N/A	N/A	N/A	N/A	N/A	0,5%
1st	14,462	N/A	49,895	28,857	N/A	99,558	100%
2nd	0,015	N/A	0,100	0,038	N/A	0,130	1%
3rd	0,034	N/A	0,233	0,020	N/A	0,070	4%
4th	0,008	N/A	0,054	0,018	N/A	0,061	1%
5th	0,014	N/A	0,098	0,028	N/A	0,097	4%
6th	0,003	N/A	0,023	0,016	N/A	0,055	1%
7th	0,014	N/A	0,099	0,046	N/A	0,160	4%
8th	0,003	N/A	0,022	0,033	N/A	0,113	1%
9th	0,022	N/A	0,154	0,031	N/A	0,107	2%
10th	0,004	N/A	0,025	0,034	N/A	0,118	0,5%
11th	0,009	N/A	0,063	0,033	N/A	0,116	2%
12th	0,002	N/A	0,014	0,006	N/A	0,020	0,5%
13th	0,007	N/A	0,048	0,006	N/A	0,019	2%
14th	0,002	N/A	0,014	0,008	N/A	0,026	0,5%
15th	0,008	N/A	0,053	0,021	N/A	0,073	1%
16th	0,002	N/A	0,012	0,013	N/A	0,046	0,5%
17th	0,004	N/A	0,027	0,016	N/A	0,056	1%
18th	0,002	N/A	0,012	0,012	N/A	0,041	0,5%
19th	0,003	N/A	0,019	0,018	N/A	0,062	1%
20th	0,002	N/A	0,017	0,014	N/A	0,047	0,5%
21th	0,005	N/A	0,037	0,005	N/A	0,016	0,6%
22th	0,001	N/A	0,010	0,007	N/A	0,024	0,5%
23th	0,003	N/A	0,023	0,011	N/A	0,038	0,6%
24th	0,002	N/A	0,012	0,005	N/A	0,018	0,5%
25th	0,002	N/A	0,015	0,010	N/A	0,035	0,6%
26th	0,002	N/A	0,011	0,007	N/A	0,023	0,5%
27th	0,002	N/A	0,014	0,006	N/A	0,022	0,6%
28th	0,002	N/A	0,014	0,008	N/A	0,027	0,5%
29th	0,003	N/A	0,017	0,017	N/A	0,060	0,6%
30th	0,001	N/A	0,010	0,006	N/A	0,019	0,5%
31th	0,003	N/A	0,024	0,007	N/A	0,023	0,6%
32th	0,002	N/A	0,011	0,004	N/A	0,013	0,5%
33th	0,002	N/A	0,014	0,004	N/A	0,013	0,6%
THD (to 50th)	N/A	N/A	0,348	N/A	N/A	0,398	5%
L2 phase							
Generating Unit rating per phase (rpp)							
	At 50% of rated output current			100% of rated output current A			
	Watts	3,343		Watts	6,675		
	VA	3,343		VA	6,675		

	Vrms	229,9	Vrms	230,3
	Arms	14,543	Arms	28,935
	PF	1,000	PF	1,000
	Frequency	50,00	Frequency	50,00

Harmonic	Value A	Angle degrees	% of fundamental	Value A	Angle degrees	% of fundamental	Limit in % of fundamental
0	N/A	N/A	N/A	N/A	N/A	N/A	0,5%
1st	14,543	N/A	50,174	28,983	N/A	99,991	100%
2nd	0,013	N/A	0,090	0,066	N/A	0,227	1%
3rd	0,015	N/A	0,102	0,010	N/A	0,034	4%
4th	0,007	N/A	0,047	0,034	N/A	0,118	1%
5th	0,039	N/A	0,266	0,057	N/A	0,196	4%
6th	0,002	N/A	0,015	0,025	N/A	0,086	1%
7th	0,029	N/A	0,203	0,044	N/A	0,152	4%
8th	0,003	N/A	0,017	0,018	N/A	0,062	1%
9th	0,011	N/A	0,078	0,025	N/A	0,086	2%
10th	0,003	N/A	0,021	0,028	N/A	0,096	0,5%
11th	0,021	N/A	0,141	0,046	N/A	0,158	2%
12th	0,002	N/A	0,011	0,007	N/A	0,023	0,5%
13th	0,014	N/A	0,098	0,005	N/A	0,017	2%
14th	0,002	N/A	0,013	0,016	N/A	0,054	0,5%
15th	0,005	N/A	0,033	0,024	N/A	0,081	1%
16th	0,001	N/A	0,010	0,005	N/A	0,017	0,5%
17th	0,009	N/A	0,059	0,005	N/A	0,017	1%
18th	0,001	N/A	0,010	0,019	N/A	0,065	0,5%
19th	0,004	N/A	0,026	0,004	N/A	0,013	1%
20th	0,002	N/A	0,015	0,004	N/A	0,014	0,5%
21th	0,003	N/A	0,024	0,006	N/A	0,021	0,6%
22th	0,001	N/A	0,010	0,004	N/A	0,014	0,5%
23th	0,002	N/A	0,015	0,009	N/A	0,032	0,6%
24th	0,001	N/A	0,010	0,004	N/A	0,014	0,5%
25th	0,002	N/A	0,014	0,005	N/A	0,018	0,6%
26th	0,001	N/A	0,009	0,004	N/A	0,015	0,5%
27th	0,002	N/A	0,013	0,010	N/A	0,035	0,6%
28th	0,002	N/A	0,014	0,003	N/A	0,011	0,5%
29th	0,002	N/A	0,017	0,007	N/A	0,023	0,6%
30th	0,001	N/A	0,009	0,009	N/A	0,032	0,5%
31th	0,003	N/A	0,018	0,012	N/A	0,040	0,6%
32th	0,001	N/A	0,009	0,003	N/A	0,011	0,5%
33th	0,002	N/A	0,015	0,006	N/A	0,020	0,6%
THD (to 50th)	N/A	N/A	0,442	N/A	N/A	0,466	5%

L3 phase

Generating Unit rating per phase (rpp)				
	At 50% of rated output current		100% of rated output currentA	
	Watts	3,337	Watts	6,664
	VA	3,337	VA	6,664
	Vrms	229,8	Vrms	230,3
	Arms	14,517	Arms	28,935
	PF	1,000	PF	1,000
	Frequency	50,00	Frequency	50,00

Harmonic	Value A	Angle degrees	% of fundamental	Value A	Angle degrees	% of fundamental	Limit in % of fundamental
0	N/A	N/A	N/A	N/A	N/A	N/A	0,5%
1st	14,517	N/A	50,082	28,935	N/A	99,825	100%
2nd	0,007	N/A	0,048	0,046	N/A	0,161	1%

3rd	0,021	N/A	0,144	0,022	N/A	0,075	4%
4th	0,008	N/A	0,052	0,022	N/A	0,074	1%
5th	0,034	N/A	0,233	0,039	N/A	0,136	4%
6th	0,003	N/A	0,018	0,010	N/A	0,035	1%
7th	0,029	N/A	0,197	0,055	N/A	0,189	4%
8th	0,002	N/A	0,016	0,034	N/A	0,119	1%
9th	0,012	N/A	0,080	0,008	N/A	0,027	2%
10th	0,003	N/A	0,019	0,031	N/A	0,107	0,5%
11th	0,020	N/A	0,136	0,047	N/A	0,162	2%
12th	0,002	N/A	0,012	0,003	N/A	0,010	0,5%
13th	0,014	N/A	0,094	0,006	N/A	0,020	2%
14th	0,002	N/A	0,014	0,009	N/A	0,032	0,5%
15th	0,004	N/A	0,025	0,005	N/A	0,017	1%
16th	0,001	N/A	0,010	0,013	N/A	0,046	0,5%
17th	0,006	N/A	0,042	0,019	N/A	0,064	1%
18th	0,001	N/A	0,010	0,008	N/A	0,027	0,5%
19th	0,005	N/A	0,033	0,016	N/A	0,055	1%
20th	0,002	N/A	0,015	0,014	N/A	0,049	0,5%
21th	0,002	N/A	0,014	0,008	N/A	0,029	0,6%
22th	0,001	N/A	0,010	0,008	N/A	0,027	0,5%
23th	0,003	N/A	0,019	0,011	N/A	0,037	0,6%
24th	0,002	N/A	0,011	0,002	N/A	0,008	0,5%
25th	0,002	N/A	0,014	0,006	N/A	0,022	0,6%
26th	0,002	N/A	0,011	0,005	N/A	0,018	0,5%
27th	0,002	N/A	0,015	0,005	N/A	0,017	0,6%
28th	0,002	N/A	0,013	0,006	N/A	0,021	0,5%
29th	0,003	N/A	0,019	0,017	N/A	0,059	0,6%
30th	0,001	N/A	0,009	0,004	N/A	0,015	0,5%
31th	0,003	N/A	0,018	0,008	N/A	0,026	0,6%
32th	0,002	N/A	0,010	0,006	N/A	0,020	0,5%
33th	0,002	N/A	0,014	0,003	N/A	0,012	0,6%
THD (to 50th)	N/A	N/A	0,422	N/A	N/A	0,424	5%

Note:

Inverter shall be connected to test circuit Figure C1 (AS4777.2), Grid nominal voltage within +/-5%, AC-Frequency 50+/-1Hz and Phase angle between 3 phases shall be 120+/-1.5°. Via DC-input set AC-output power (VA) so that it equals to 100+/-5% of rated output. Harmonic ratios of the test voltage shall be measured. Limits based on percentage of fundamental! Total harmonic distortion to the 50th harmonic 5%.

5.6 Harmonic currents Appendix C3 Harmonic Voltage Limit Test SOFAR 20000TL-Sx Series					P
Generating Unit rating per phase (rpp)					
	At 50% of rated output current		100% of rated output current		
	A		A		
Harmonic	Value V	% of fundamental	Value V	% of fundamental	Limit in % of fundamental
L1 phase					
2nd	0,018	0,008	0,014	0,006	0,2%
3rd	0,058	0,025	0,064	0,028	4%
4th	0,011	0,005	0,012	0,005	0,2%
5th	0,076	0,033	0,039	0,017	4%
6th	0,011	0,005	0,007	0,003	0,2%
7th	0,035	0,015	0,025	0,011	4%
8th	0,006	0,003	0,006	0,003	0,2%
9th	0,022	0,010	0,009	0,004	2%
10th	0,012	0,005	0,007	0,003	0,2%
11th	0,011	0,005	0,009	0,004	0,1%
12th	0,010	0,004	0,007	0,003	0,1%
13th	0,018	0,008	0,007	0,003	0,1%
14th	0,008	0,003	0,010	0,004	0,1%
15th	0,008	0,003	0,006	0,003	0,1%
16th	0,007	0,003	0,006	0,002	0,1%
17th	0,015	0,007	0,007	0,003	0,1%
18th	0,005	0,002	0,007	0,003	0,1%
19th	0,006	0,003	0,012	0,005	0,1%
20th	0,010	0,004	0,009	0,004	0,1%
21th	0,015	0,007	0,006	0,003	0,1%
22th	0,004	0,002	0,006	0,003	0,1%
23th	0,011	0,005	0,014	0,006	0,1%
24th	0,004	0,002	0,007	0,003	0,1%
25th	0,008	0,004	0,015	0,006	0,1%
26th	0,004	0,002	0,006	0,003	0,1%
27th	0,011	0,005	0,006	0,002	0,1%
28th	0,007	0,003	0,009	0,004	0,1%
29th	0,010	0,005	0,014	0,006	0,1%
30th	0,004	0,002	0,006	0,003	0,1%
31th	0,008	0,004	0,007	0,003	0,1%
32th	0,006	0,002	0,005	0,002	0,1%
33th	0,008	0,003	0,006	0,003	0,1%
34th	0,007	0,003	0,005	0,002	0,1%
35th	0,011	0,005	0,016	0,007	0,1%
36th	0,008	0,003	0,005	0,002	0,1%
37th	0,012	0,005	0,012	0,005	0,1%
38th	0,007	0,003	0,006	0,003	0,1%
39th	0,010	0,004	0,007	0,003	0,1%
40th	0,009	0,004	0,008	0,003	0,1%
41th	0,015	0,006	0,018	0,008	0,1%
42th	0,009	0,004	0,008	0,004	0,1%
43th	0,017	0,007	0,018	0,008	0,1%
44th	0,011	0,005	0,009	0,004	0,1%
45th	0,013	0,006	0,010	0,004	0,1%
46th	0,011	0,005	0,010	0,004	0,1%
47th	0,019	0,008	0,023	0,010	0,1%

48th	0,010	0,004	0,010	0,004	0,1%
49th	0,019	0,008	0,018	0,008	0,1%
50th	0,009	0,004	0,010	0,004	0,1%
THD	N/A	0,055	N/A	0,046	5%
L2 phase					
2nd	0,019	0,008	0,014	0,006	0,2%
3rd	0,053	0,023	0,061	0,027	4%
4th	0,007	0,003	0,008	0,004	0,2%
5th	0,074	0,032	0,038	0,017	4%
6th	0,011	0,005	0,007	0,003	0,2%
7th	0,040	0,017	0,022	0,009	4%
8th	0,005	0,002	0,008	0,004	0,2%
9th	0,027	0,012	0,021	0,009	2%
10th	0,013	0,005	0,006	0,003	0,2%
11th	0,016	0,007	0,010	0,004	0,1%
12th	0,007	0,003	0,009	0,004	0,1%
13th	0,017	0,008	0,009	0,004	0,1%
14th	0,009	0,004	0,014	0,006	0,1%
15th	0,005	0,002	0,021	0,009	0,1%
16th	0,008	0,003	0,006	0,002	0,1%
17th	0,017	0,007	0,004	0,002	0,1%
18th	0,007	0,003	0,007	0,003	0,1%
19th	0,004	0,002	0,004	0,002	0,1%
20th	0,008	0,003	0,005	0,002	0,1%
21th	0,014	0,006	0,004	0,002	0,1%
22th	0,003	0,001	0,005	0,002	0,1%
23th	0,009	0,004	0,010	0,004	0,1%
24th	0,007	0,003	0,005	0,002	0,1%
25th	0,008	0,003	0,009	0,004	0,1%
26th	0,004	0,002	0,004	0,002	0,1%
27th	0,010	0,005	0,010	0,004	0,1%
28th	0,005	0,002	0,004	0,002	0,1%
29th	0,011	0,005	0,009	0,004	0,1%
30th	0,004	0,002	0,009	0,004	0,1%
31th	0,006	0,003	0,012	0,005	0,1%
32th	0,004	0,002	0,004	0,002	0,1%
33th	0,007	0,003	0,005	0,002	0,1%
34th	0,004	0,002	0,005	0,002	0,1%
35th	0,011	0,005	0,012	0,005	0,1%
36th	0,004	0,002	0,006	0,003	0,1%
37th	0,012	0,005	0,014	0,006	0,1%
38th	0,006	0,003	0,005	0,002	0,1%
39th	0,011	0,005	0,006	0,003	0,1%
40th	0,006	0,003	0,006	0,003	0,1%
41th	0,017	0,007	0,016	0,007	0,1%
42th	0,007	0,003	0,006	0,003	0,1%
43th	0,016	0,007	0,018	0,008	0,1%
44th	0,007	0,003	0,006	0,003	0,1%
45th	0,010	0,004	0,008	0,003	0,1%
46th	0,008	0,004	0,007	0,003	0,1%
47th	0,018	0,008	0,020	0,008	0,1%
48th	0,007	0,003	0,008	0,003	0,1%
49th	0,020	0,009	0,019	0,008	0,1%
50th	0,007	0,003	0,009	0,004	0,1%
THD	N/A	0,054	N/A	0,044	5%
L3 phase					
2nd	0,017	0,007	0,014	0,006	0,2%

3rd	0,071	0,031	0,061	0,026	4%
4th	0,009	0,004	0,012	0,005	0,2%
5th	0,077	0,033	0,036	0,015	4%
6th	0,012	0,005	0,005	0,002	0,2%
7th	0,033	0,014	0,029	0,013	4%
8th	0,005	0,002	0,009	0,004	0,2%
9th	0,029	0,013	0,015	0,006	2%
10th	0,012	0,005	0,006	0,002	0,2%
11th	0,011	0,005	0,007	0,003	0,1%
12th	0,009	0,004	0,006	0,003	0,1%
13th	0,016	0,007	0,006	0,003	0,1%
14th	0,007	0,003	0,012	0,005	0,1%
15th	0,004	0,002	0,009	0,004	0,1%
16th	0,009	0,004	0,006	0,003	0,1%
17th	0,017	0,007	0,009	0,004	0,1%
18th	0,006	0,003	0,008	0,003	0,1%
19th	0,005	0,002	0,008	0,003	0,1%
20th	0,010	0,004	0,012	0,005	0,1%
21th	0,014	0,006	0,006	0,003	0,1%
22th	0,003	0,001	0,006	0,003	0,1%
23th	0,007	0,003	0,013	0,005	0,1%
24th	0,008	0,004	0,005	0,002	0,1%
25th	0,008	0,004	0,011	0,005	0,1%
26th	0,004	0,002	0,007	0,003	0,1%
27th	0,014	0,006	0,006	0,003	0,1%
28th	0,004	0,002	0,007	0,003	0,1%
29th	0,010	0,005	0,017	0,008	0,1%
30th	0,004	0,002	0,004	0,002	0,1%
31th	0,008	0,003	0,010	0,004	0,1%
32th	0,004	0,002	0,006	0,003	0,1%
33th	0,007	0,003	0,006	0,003	0,1%
34th	0,004	0,002	0,004	0,002	0,1%
35th	0,011	0,005	0,015	0,006	0,1%
36th	0,004	0,002	0,004	0,002	0,1%
37th	0,011	0,005	0,013	0,006	0,1%
38th	0,005	0,002	0,005	0,002	0,1%
39th	0,009	0,004	0,007	0,003	0,1%
40th	0,005	0,002	0,005	0,002	0,1%
41th	0,014	0,006	0,017	0,007	0,1%
42th	0,005	0,002	0,006	0,002	0,1%
43th	0,016	0,007	0,019	0,008	0,1%
44th	0,006	0,003	0,006	0,003	0,1%
45th	0,010	0,005	0,009	0,004	0,1%
46th	0,006	0,003	0,007	0,003	0,1%
47th	0,018	0,008	0,022	0,010	0,1%
48th	0,006	0,002	0,007	0,003	0,1%
49th	0,020	0,009	0,020	0,009	0,1%
50th	0,005	0,002	0,007	0,003	0,1%
THD	N/A	0,057	N/A	0,045	5%

Note:

Inverter shall be connected to test circuit Figure C1 (AS4777.2), Grid nominal voltage within +/-5%, AC-Frequency 50+/-1Hz and Phase angle between 3 phases shall be 120+/-1.5°. Via DC-input set AC-output power (VA) so that it equals to 100+/-5% of rated output. Harmonic ratios of the test voltage shall be measured. Limits based on percentage of fundamental! Total harmonic distortion to the 50th harmonic 5%.

5.6 Harmonic currents Appendix C Harmonic Current Limit Test							P
SOFAR 10000TL-Sx Series							
L1 phase							
Generating Unit rating per phase (rpp)							
	At 50% of rated output current			100% of rated output currentA			
	Watts	1,622		Watts	3,328		
	VA	1,622		VA	3,328		
	Vrms	230,5		Vrms	230,8		
	Arms	7,210		Arms	14,422		
	PF	1,000		PF	1,000		
	Frequency	50,00		Frequency	50,00		
Harmonic	Value A	Angle degrees	% of fundamental	Value A	Angle degrees	% of fundamental	Limit in % of fundamental
0	N/A	N/A	N/A	N/A	N/A	N/A	0,5%
1st	7,210	N/A	49,751	14,422	N/A	99,513	100%
2nd	0,007	N/A	0,100	0,021	N/A	0,146	1%
3rd	0,047	N/A	0,654	0,048	N/A	0,334	4%
4th	0,012	N/A	0,171	0,012	N/A	0,081	1%
5th	0,098	N/A	1,353	0,100	N/A	0,690	4%
6th	0,003	N/A	0,038	0,006	N/A	0,042	1%
7th	0,060	N/A	0,831	0,092	N/A	0,639	4%
8th	0,002	N/A	0,031	0,008	N/A	0,057	1%
9th	0,015	N/A	0,207	0,006	N/A	0,042	2%
10th	0,002	N/A	0,023	0,007	N/A	0,048	0,5%
11th	0,018	N/A	0,243	0,053	N/A	0,367	2%
12th	0,002	N/A	0,024	0,002	N/A	0,016	0,5%
13th	0,010	N/A	0,133	0,032	N/A	0,220	2%
14th	0,002	N/A	0,031	0,002	N/A	0,017	0,5%
15th	0,004	N/A	0,053	0,010	N/A	0,073	1%
16th	0,002	N/A	0,022	0,002	N/A	0,014	0,5%
17th	0,004	N/A	0,052	0,022	N/A	0,153	1%
18th	0,001	N/A	0,017	0,001	N/A	0,009	0,5%
19th	0,010	N/A	0,143	0,022	N/A	0,150	1%
20th	0,002	N/A	0,034	0,001	N/A	0,010	0,5%
21th	0,005	N/A	0,070	0,008	N/A	0,053	0,6%
22th	0,001	N/A	0,017	0,002	N/A	0,011	0,5%
23th	0,015	N/A	0,208	0,015	N/A	0,102	0,6%
24th	0,001	N/A	0,018	0,002	N/A	0,012	0,5%
25th	0,014	N/A	0,189	0,009	N/A	0,063	0,6%
26th	0,002	N/A	0,022	0,002	N/A	0,016	0,5%
27th	0,003	N/A	0,036	0,007	N/A	0,048	0,6%
28th	0,001	N/A	0,018	0,002	N/A	0,011	0,5%
29th	0,010	N/A	0,135	0,005	N/A	0,035	0,6%
30th	0,001	N/A	0,012	0,001	N/A	0,007	0,5%
31th	0,013	N/A	0,175	0,006	N/A	0,043	0,6%
32th	0,001	N/A	0,016	0,001	N/A	0,008	0,5%
33th	0,003	N/A	0,047	0,007	N/A	0,046	0,6%
THD (to 50th)	N/A	N/A	1,820	N/A	N/A	1,141	5%
L2 phase							
Generating Unit rating per phase (rpp)							
	At 50% of rated output current			100% of rated output currentA			
	Watts	1,644		Watts	3,305		
	VA	1,644		VA	3,305		

	Vrms	230,4	Vrms	230,7			
	Arms	7,136	Arms	14,325			
	PF	1,000	PF	1,000			
	Frequency	50,00	Frequency	50,00			
Harmonic	Value A	Angle degrees	% of fundamental	Value A	Angle degrees	% of fundamental	Limit in % of fundamental
0	N/A	N/A	N/A	N/A	N/A	N/A	0,5%
1st	7,136	N/A	49,236	14,325	N/A	98,943	100%
2nd	0,015	N/A	0,205	0,027	N/A	0,187	1%
3rd	0,018	N/A	0,248	0,031	N/A	0,215	4%
4th	0,009	N/A	0,129	0,008	N/A	0,058	1%
5th	0,109	N/A	1,529	0,106	N/A	0,742	4%
6th	0,004	N/A	0,052	0,008	N/A	0,054	1%
7th	0,043	N/A	0,597	0,074	N/A	0,516	4%
8th	0,004	N/A	0,058	0,005	N/A	0,035	1%
9th	0,002	N/A	0,035	0,006	N/A	0,042	2%
10th	0,003	N/A	0,042	0,003	N/A	0,020	0,5%
11th	0,030	N/A	0,418	0,054	N/A	0,374	2%
12th	0,003	N/A	0,038	0,002	N/A	0,015	0,5%
13th	0,007	N/A	0,100	0,027	N/A	0,188	2%
14th	0,004	N/A	0,052	0,003	N/A	0,022	0,5%
15th	0,006	N/A	0,090	0,008	N/A	0,056	1%
16th	0,002	N/A	0,024	0,003	N/A	0,021	0,5%
17th	0,006	N/A	0,083	0,028	N/A	0,197	1%
18th	0,002	N/A	0,021	0,002	N/A	0,013	0,5%
19th	0,011	N/A	0,157	0,018	N/A	0,126	1%
20th	0,003	N/A	0,038	0,002	N/A	0,011	0,5%
21th	0,004	N/A	0,054	0,005	N/A	0,035	0,6%
22th	0,001	N/A	0,015	0,002	N/A	0,016	0,5%
23th	0,013	N/A	0,189	0,018	N/A	0,124	0,6%
24th	0,001	N/A	0,015	0,002	N/A	0,015	0,5%
25th	0,011	N/A	0,159	0,007	N/A	0,046	0,6%
26th	0,001	N/A	0,015	0,003	N/A	0,021	0,5%
27th	0,002	N/A	0,023	0,004	N/A	0,025	0,6%
28th	0,002	N/A	0,024	0,001	N/A	0,010	0,5%
29th	0,011	N/A	0,150	0,009	N/A	0,061	0,6%
30th	0,001	N/A	0,010	0,001	N/A	0,009	0,5%
31th	0,009	N/A	0,129	0,003	N/A	0,020	0,6%
32th	0,001	N/A	0,013	0,001	N/A	0,008	0,5%
33th	0,004	N/A	0,051	0,005	N/A	0,038	0,6%
THD (to 50th)	N/A	N/A	1,789	N/A	N/A	1,085	5%
L3 phase							
Generating Unit rating per phase (rpp)							
	At 50% of rated output current			100% of rated output currentA			
	Watts	1,685	Watts	3,355			
	VA	1,685	VA	3,355			
	Vrms	230,5	Vrms	230,7			
	Arms	7,311	Arms	14,544			
	PF	1,000	PF	1,000			
	Frequency	50,00	Frequency	50,00			
Harmonic	Value A	Angle degrees	% of fundamental	Value A	Angle degrees	% of fundamental	Limit in % of fundamental
0	N/A	N/A	N/A	N/A	N/A	N/A	0,5%
1st	7.311	N/A	50,443	14.544	N/A	100,355	100%
2nd	0.018	N/A	0.251	0.031	N/A	0.213	1%

3rd	0.031	N/A	0.429	0.022	N/A	0.150	4%
4th	0.011	N/A	0.154	0.009	N/A	0.060	1%
5th	0.081	N/A	1.110	0.092	N/A	0.633	4%
6th	0.003	N/A	0.038	0.003	N/A	0.022	1%
7th	0.065	N/A	0.895	0.094	N/A	0.644	4%
8th	0.004	N/A	0.052	0.006	N/A	0.041	1%
9th	0.017	N/A	0.232	0.010	N/A	0.072	2%
10th	0.002	N/A	0.032	0.005	N/A	0.035	0,5%
11th	0.015	N/A	0.208	0.041	N/A	0.282	2%
12th	0.002	N/A	0.029	0.002	N/A	0.013	0,5%
13th	0.015	N/A	0.208	0.036	N/A	0.246	2%
14th	0.002	N/A	0.032	0.004	N/A	0.028	0,5%
15th	0.008	N/A	0.115	0.005	N/A	0.031	1%
16th	0.001	N/A	0.015	0.003	N/A	0.023	0,5%
17th	0.009	N/A	0.118	0.021	N/A	0.147	1%
18th	0.001	N/A	0.018	0.002	N/A	0.011	0,5%
19th	0.010	N/A	0.139	0.026	N/A	0.179	1%
20th	0.002	N/A	0.025	0.002	N/A	0.012	0,5%
21th	0.003	N/A	0.035	0.006	N/A	0.040	0,6%
22th	0.001	N/A	0.014	0.002	N/A	0.012	0,5%
23th	0.016	N/A	0.213	0.011	N/A	0.073	0,6%
24th	0.002	N/A	0.023	0.002	N/A	0.014	0,5%
25th	0.014	N/A	0.191	0.013	N/A	0.089	0,6%
26th	0.001	N/A	0.014	0.003	N/A	0.018	0,5%
27th	0.003	N/A	0.042	0.003	N/A	0.021	0,6%
28th	0.002	N/A	0.021	0.002	N/A	0.013	0,5%
29th	0.011	N/A	0.145	0.005	N/A	0.037	0,6%
30th	0.001	N/A	0.015	0.001	N/A	0.009	0,5%
31th	0.011	N/A	0.156	0.007	N/A	0.047	0,6%
32th	0.001	N/A	0.011	0.001	N/A	0.009	0,5%
33th	0.004	N/A	0.052	0.004	N/A	0.025	0,6%
THD (to 50th)	N/A	N/A	1,631	N/A	N/A	1,058	5%

Note:

Inverter shall be connected to test circuit Figure C1 (AS4777.2), Grid nominal voltage within +/-5%, AC-Frequency 50+/-1Hz and Phase angle between 3 phases shall be 120+/-1.5°. Via DC-input set AC-output power (VA) so that it equals to 100+/-5% of rated output. Harmonic ratios of the test voltage shall be measured. Limits based on percentage of fundamental! Total harmonic distortion to the 50th harmonic 5%.

The tests had been performed on the SOFAR 10000TL-Sx Series and SOFAR 20000TL-Sx Series are valid for the SOFAR 15000TL-Sx Series and SOFAR 17000TL-Sx Series, since it is similar in hardware and just power derated by software.

5.6 Harmonic currents Appendix C3 Harmonic Voltage Limit Test SOFAR 10000TL-Sx Series					P
Generating Unit rating per phase (rpp)					
	At 50% of rated output current		100% of rated output current		
	A		A		
Harmonic	Value V	% of fundamental	Value V	% of fundamental	Limit in % of fundamental
L1 phase					
2nd	0,012	0,005	0,010	0,005	0,2%
3rd	0,062	0,027	0,061	0,026	4%
4th	0,008	0,003	0,007	0,003	0,2%
5th	0,084	0,036	0,064	0,028	4%
6th	0,008	0,004	0,008	0,003	0,2%
7th	0,033	0,014	0,010	0,004	4%
8th	0,005	0,002	0,010	0,004	0,2%
9th	0,024	0,011	0,024	0,011	2%
10th	0,010	0,004	0,002	0,001	0,2%
11th	0,006	0,003	0,020	0,009	0,1%
12th	0,010	0,004	0,009	0,004	0,1%
13th	0,018	0,008	0,024	0,011	0,1%
14th	0,003	0,001	0,004	0,002	0,1%
15th	0,004	0,002	0,006	0,002	0,1%
16th	0,007	0,003	0,005	0,002	0,1%
17th	0,012	0,005	0,011	0,005	0,1%
18th	0,003	0,001	0,005	0,002	0,1%
19th	0,012	0,005	0,015	0,007	0,1%
20th	0,011	0,005	0,004	0,002	0,1%
21th	0,012	0,005	0,010	0,004	0,1%
22th	0,004	0,002	0,004	0,002	0,1%
23th	0,014	0,006	0,015	0,007	0,1%
24th	0,003	0,001	0,006	0,003	0,1%
25th	0,014	0,006	0,016	0,007	0,1%
26th	0,005	0,002	0,004	0,002	0,1%
27th	0,013	0,006	0,014	0,006	0,1%
28th	0,005	0,002	0,005	0,002	0,1%
29th	0,014	0,006	0,008	0,004	0,1%
30th	0,003	0,001	0,004	0,002	0,1%
31th	0,014	0,006	0,009	0,004	0,1%
32th	0,005	0,002	0,007	0,003	0,1%
33th	0,008	0,004	0,010	0,005	0,1%
34th	0,006	0,003	0,005	0,002	0,1%
35th	0,014	0,006	0,009	0,004	0,1%
36th	0,005	0,002	0,006	0,003	0,1%
37th	0,011	0,005	0,005	0,002	0,1%
38th	0,004	0,002	0,005	0,002	0,1%
39th	0,007	0,003	0,008	0,003	0,1%
40th	0,006	0,002	0,007	0,003	0,1%
41th	0,008	0,004	0,006	0,002	0,1%
42th	0,005	0,002	0,005	0,002	0,1%
43th	0,011	0,005	0,010	0,004	0,1%
44th	0,007	0,003	0,008	0,003	0,1%
45th	0,008	0,004	0,009	0,004	0,1%
46th	0,004	0,002	0,006	0,003	0,1%
47th	0,009	0,004	0,011	0,005	0,1%

48th	0,007	0,003	0,007	0,003	0,1%
49th	0,007	0,003	0,008	0,004	0,1%
50th	0,004	0,002	0,005	0,002	0,1%
THD	N/A	0,055	N/A	0,049	5%
L2 phase					
2nd	0,014	0,006	0,011	0,005	0,2%
3rd	0,058	0,025	0,055	0,024	4%
4th	0,005	0,002	0,006	0,003	0,2%
5th	0,086	0,037	0,068	0,030	4%
6th	0,010	0,004	0,007	0,003	0,2%
7th	0,037	0,016	0,010	0,004	4%
8th	0,003	0,002	0,009	0,004	0,2%
9th	0,027	0,012	0,028	0,012	2%
10th	0,012	0,005	0,006	0,003	0,2%
11th	0,010	0,004	0,020	0,008	0,1%
12th	0,009	0,004	0,010	0,004	0,1%
13th	0,019	0,008	0,027	0,012	0,1%
14th	0,007	0,003	0,003	0,001	0,1%
15th	0,003	0,001	0,009	0,004	0,1%
16th	0,008	0,003	0,009	0,004	0,1%
17th	0,015	0,006	0,013	0,005	0,1%
18th	0,004	0,002	0,004	0,002	0,1%
19th	0,012	0,005	0,016	0,007	0,1%
20th	0,010	0,004	0,005	0,002	0,1%
21th	0,014	0,006	0,007	0,003	0,1%
22th	0,002	0,001	0,008	0,003	0,1%
23th	0,013	0,005	0,016	0,007	0,1%
24th	0,006	0,003	0,003	0,001	0,1%
25th	0,014	0,006	0,013	0,006	0,1%
26th	0,002	0,001	0,004	0,002	0,1%
27th	0,013	0,005	0,010	0,004	0,1%
28th	0,005	0,002	0,005	0,002	0,1%
29th	0,016	0,007	0,009	0,004	0,1%
30th	0,004	0,002	0,004	0,002	0,1%
31th	0,012	0,005	0,008	0,004	0,1%
32th	0,002	0,001	0,004	0,002	0,1%
33th	0,008	0,003	0,005	0,002	0,1%
34th	0,003	0,001	0,005	0,002	0,1%
35th	0,014	0,006	0,009	0,004	0,1%
36th	0,002	0,001	0,004	0,002	0,1%
37th	0,012	0,005	0,007	0,003	0,1%
38th	0,004	0,002	0,004	0,002	0,1%
39th	0,011	0,005	0,007	0,003	0,1%
40th	0,003	0,001	0,005	0,002	0,1%
41th	0,013	0,005	0,007	0,003	0,1%
42th	0,003	0,001	0,006	0,003	0,1%
43th	0,013	0,006	0,013	0,005	0,1%
44th	0,003	0,001	0,003	0,001	0,1%
45th	0,008	0,003	0,005	0,002	0,1%
46th	0,004	0,002	0,005	0,002	0,1%
47th	0,011	0,005	0,011	0,005	0,1%
48th	0,003	0,001	0,005	0,002	0,1%
49th	0,011	0,005	0,015	0,007	0,1%
50th	0,005	0,002	0,005	0,002	0,1%
THD	N/A	0,056	N/A	0,049	5%
L3 phase					
2nd	0,013	0,006	0,011	0,005	0,2%

3rd	0,059	0,025	0,057	0,025	4%
4th	0,007	0,003	0,007	0,003	0,2%
5th	0,086	0,037	0,070	0,030	4%
6th	0,011	0,005	0,008	0,004	0,2%
7th	0,033	0,014	0,010	0,004	4%
8th	0,005	0,002	0,010	0,004	0,2%
9th	0,031	0,013	0,029	0,013	2%
10th	0,012	0,005	0,003	0,001	0,2%
11th	0,008	0,003	0,020	0,009	0,1%
12th	0,010	0,004	0,010	0,004	0,1%
13th	0,015	0,007	0,024	0,010	0,1%
14th	0,005	0,002	0,003	0,001	0,1%
15th	0,005	0,002	0,008	0,004	0,1%
16th	0,009	0,004	0,008	0,003	0,1%
17th	0,012	0,005	0,012	0,005	0,1%
18th	0,004	0,002	0,005	0,002	0,1%
19th	0,011	0,005	0,017	0,007	0,1%
20th	0,011	0,005	0,004	0,002	0,1%
21th	0,014	0,006	0,006	0,003	0,1%
22th	0,005	0,002	0,007	0,003	0,1%
23th	0,011	0,005	0,012	0,005	0,1%
24th	0,008	0,003	0,003	0,001	0,1%
25th	0,017	0,007	0,016	0,007	0,1%
26th	0,004	0,002	0,003	0,001	0,1%
27th	0,015	0,007	0,010	0,004	0,1%
28th	0,003	0,001	0,004	0,002	0,1%
29th	0,014	0,006	0,007	0,003	0,1%
30th	0,006	0,003	0,003	0,001	0,1%
31th	0,014	0,006	0,010	0,004	0,1%
32th	0,003	0,001	0,003	0,001	0,1%
33th	0,007	0,003	0,006	0,003	0,1%
34th	0,003	0,001	0,004	0,002	0,1%
35th	0,014	0,006	0,008	0,004	0,1%
36th	0,003	0,001	0,003	0,001	0,1%
37th	0,009	0,004	0,005	0,002	0,1%
38th	0,005	0,002	0,003	0,001	0,1%
39th	0,007	0,003	0,006	0,003	0,1%
40th	0,002	0,001	0,003	0,001	0,1%
41th	0,010	0,004	0,009	0,004	0,1%
42th	0,004	0,002	0,005	0,002	0,1%
43th	0,011	0,005	0,010	0,004	0,1%
44th	0,004	0,002	0,003	0,001	0,1%
45th	0,007	0,003	0,006	0,003	0,1%
46th	0,003	0,001	0,004	0,002	0,1%
47th	0,008	0,003	0,014	0,006	0,1%
48th	0,003	0,001	0,004	0,002	0,1%
49th	0,008	0,003	0,011	0,005	0,1%
50th	0,004	0,002	0,004	0,002	0,1%
THD	N/A	0,056	N/A	0,049	5%

Note:

Inverter shall be connected to test circuit Figure C1 (AS4777.2), Grid nominal voltage within +/-5%, AC-Frequency 50+/-1Hz and Phase angle between 3 phases shall be 120+/-1.5°. Via DC-input set AC-output power (VA) so that it equals to 100+/-5% of rated output. Harmonic ratios of the test voltage shall be measured. Limits based on percentage of fundamental! Total harmonic distortion to the 50th harmonic 5%.

The tests had been performed on the SOFAR 10000TL-Sx Series and SOFAR 20000TL-Sx Series are valid for the SOFAR 15000TL-Sx Series and SOFAR 17000TL-Sx Series, since it is similar in hardware and just power derated by software.

5.7 Voltage Fluctuations and Flicker			P
SOFAR 10000TL-Sx Series			
Phase 1			
Limit	Pst = 1,0	Plt = 0,65	
Test value	0,07	0,07	
Phase 2			
Limit	Pst = 1,0	Plt = 0,65	
Test value	0,07	0,07	
Phase 3			
Limit	Pst = 1,0	Plt = 0,65	
Test value	0,07	0,07	
SOFAR 20000TL-Sx Series			
Phase 1			
Limit	Pst = 1,0	Plt = 0,65	
Test value	0,12	0,11	
Phase 2			
Limit	Pst = 1,0	Plt = 0,65	
Test value	0,12	0,11	
Phase 3			
Limit	Pst = 1,0	Plt = 0,65	
Test value	0,12	0,11	
<p>Note:</p> <p>The inverter shall conform to the voltage fluctuation and flicker limits specified in AS/NZS 61000.3.3 for equipment with rated current less than or equal to 16 A per phase (a.c.). For equipment with rated current greater than 16 A per phase (a.c.), if the inverter cannot meet the requirements of AS/NZS 61000.3.3, the maximum permissible connection point impedance (Zmax) shall be determined such that the voltage fluctuation and flicker limits specified in AS/NZS 61000.3.3 can be met. The impedance shall be determined in accordance with the methods given in AS/NZS 61000.3.11.</p> <p>The tests had been performed on the SOFAR 10000TL-Sx Series and SOFAR 20000TL-Sx Series are valid for the SOFAR 15000TL-Sx Series and SOFAR 17000TL-Sx Series, since it is similar in hardware and just power derated by software.</p>			

5.8 Transient Voltage Limits (phase to neutral) Appendix D Transient Voltage Limit Test						P
L1 phase						
	10+/-5% Output Power (VA)		50+/-5% Output Power (VA)		100+/-5% Output Power (VA)	
	Duration (s)	Line to neutral (V)	Duration (s)	Line to neutral (V)	Duration (s)	Line to neutral (V)
Limit	0,002	580	0,002	580	0,002	580
Test value	0,002	409,6	0,002	167,3	0,002	156,9
Limit	0,006	470	0,006	470	0,006	470
Test value	0,006	407,7	0,006	165,4	0,006	156,9
Limit	0,02	420	0,02	420	0,02	420
Test value	0,02	403,8	0,02	165,4	0,02	153,8
Limit	>0,06	390	>0,06	390	>0,06	390
Test value	>0,06	379,2	>0,06	161,5	>0,06	150,7

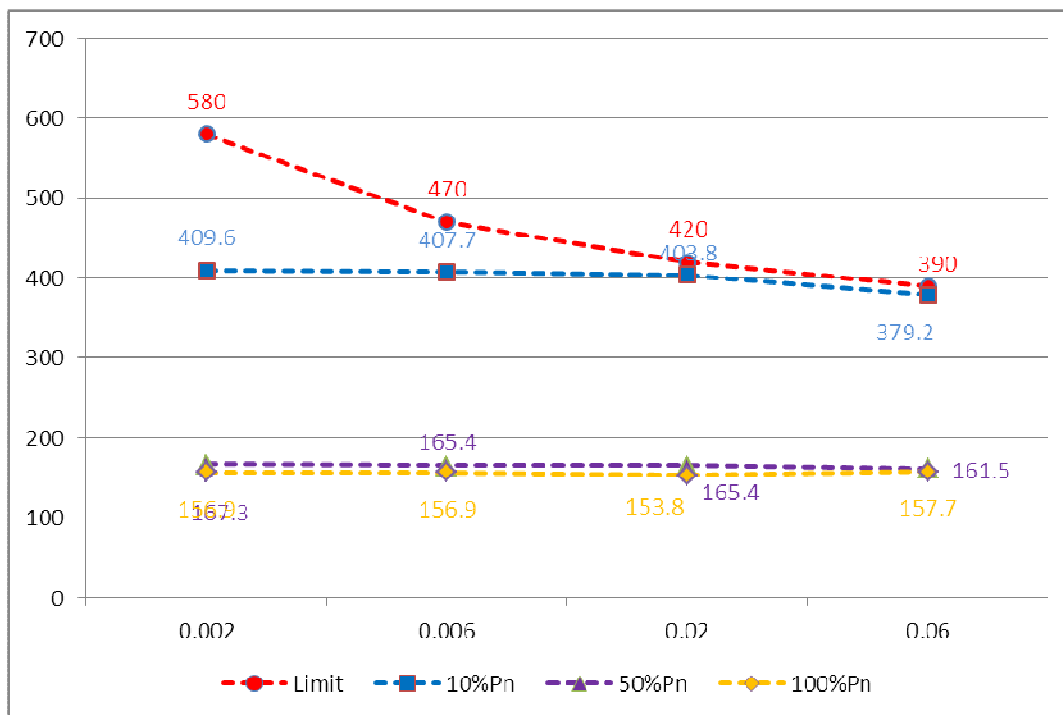

L2 phase						
	10+/-5% Output Power (VA)		50+/-5% Output Power (VA)		100+/-5% Output Power (VA)	
	Duration (s)	Line to neutral (V)	Duration (s)	Line to neutral (V)	Duration (s)	Line to neutral (V)
Limit	0,002	580	0,002	580	0,002	580
Test value	0,002	234,5	0,002	465,4	0,002	166,1
Limit	0,006	470	0,006	470	0,006	470
Test value	0,006	232,6	0,006	440,4	0,006	163,1
Limit	0,02	420	0,02	420	0,02	420
Test value	0,02	223,1	0,02	411,1	0,02	156,9
Limit	>0,06	390	>0,06	390	>0,06	390
Test value	>0,06	196,2	>0,06	369,2	>0,06	138,5

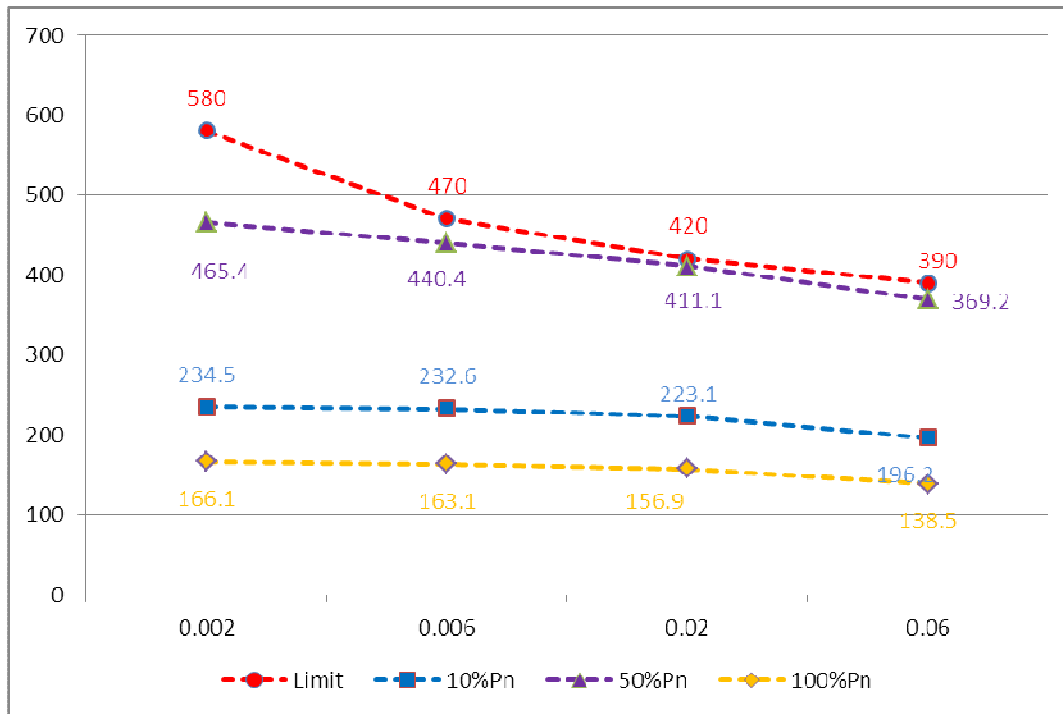

L3 phase						
	10+/-5% Output Power (VA)		50+/-5% Output Power (VA)		100+/-5% Output Power (VA)	
	Duration (s)	Line to neutral (V)	Duration (s)	Line to neutral (V)	Duration (s)	Line to neutral (V)
Limit	0,002	580	0,002	580	0,002	580
Test value	0,002	153,8	0,002	288,5	0,002	329,2
Limit	0,006	470	0,006	470	0,006	470
Test value	0,006	150,1	0,006	240,4	0,006	326,1
Limit	0,02	420	0,02	420	0,02	420
Test value	0,02	144,2	0,02	230,8	0,02	310,8
Limit	>0,06	390	>0,06	390	>0,06	390
Test value	>0,06	126,9	>0,06	201,9	>0,06	273,8

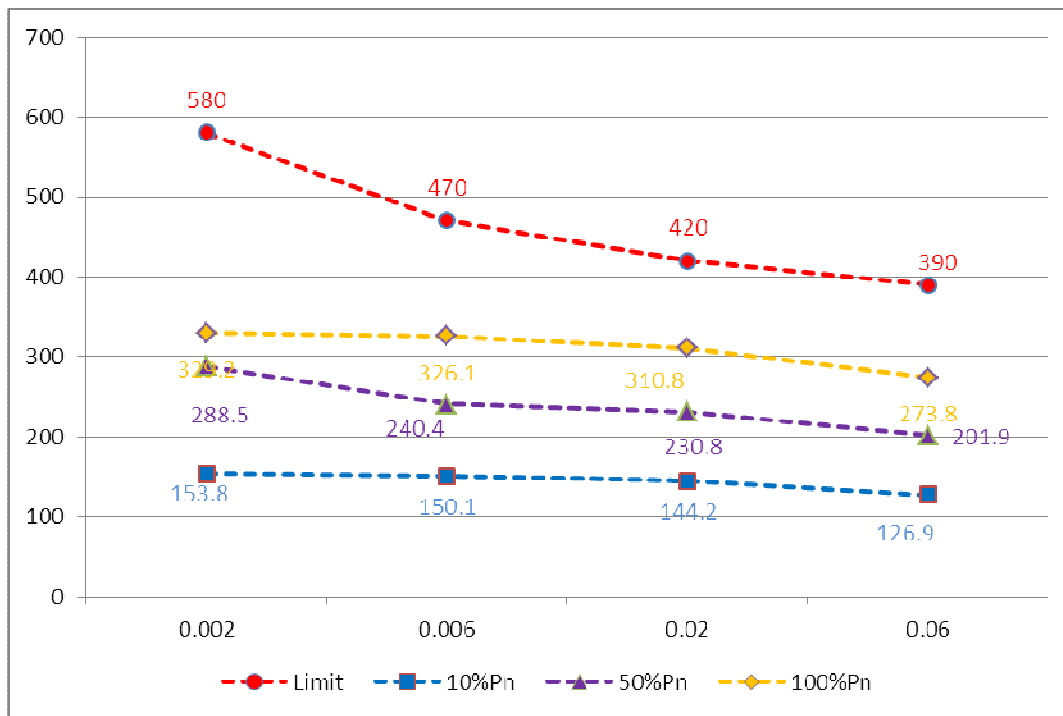

Note:

Results shall not exceed limits in Table 4 of AS/NZS 4777.2. Test Specifications: Inverter shall be connected to test circuit AS/NZS 4777.2 Figure D1. Grid nominal voltage within +/-5%, Via DC-input set AC- output power so that it equals to 10+/-5% of rated output (VA). Switch S shall be opened and the output voltage duration (Sample frequency of at least 10kHz) of the inverter shall be recorded. Test shall be repeated at 50+/-5% and 100+/-5% of rated output power.

The tests had been performed on the SOFAR 20000TL-Sx Series is valid for the SOFAR 10000TL-Sx Series, SOFAR 15000TL-Sx Series and SOFAR 17000TL-Sx Series, since it is similar in hardware and just power derated by software.

5.9 Direct current injection Appendix E D.C. injection test	P
--	---

SOFAR 10000TL-Sx Series							
Testing at 20+/-5% Output Power							
Phases	L1-L1 (mA)	L1-L2 (mA)	L1-L3 (mA)	L2-L3 (mA)	L1-N (mA)	L2-N (mA)	L3-N (mA)
Test value	Three phase!	Three phase!	Three phase!	Three phase!	-30,0	-51,0	-57,0
Testing at 60+/-5% Output Power							
Phases	L1-L1 (mA)	L1-L2 (mA)	L1-L3 (mA)	L2-L3 (mA)	L1-N (mA)	L2-N (mA)	L3-N (mA)
Test value	Three phase!	Three phase!	Three phase!	Three phase!	-30,0	-50,0	-56,0
Testing at 100+/-5% Output Power							
Phases	L1-L1 (mA)	L1-L2 (mA)	L1-L3 (mA)	L2-L3 (mA)	L1-N (mA)	L2-N (mA)	L3-N (mA)
Test value	Three phase!	Three phase!	Three phase!	Three phase!	-29,0	-45,0	-54,0

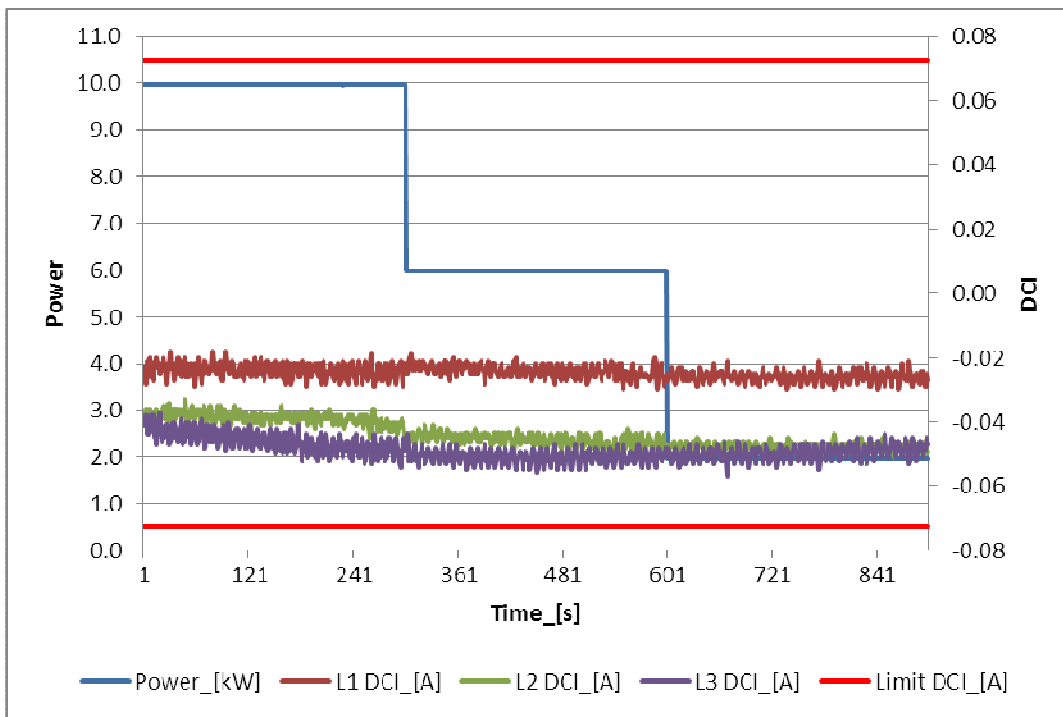

SOFAR 20000TL-Sx Series							
Testing at 20+/-5% Output Power							
Phases	L1-L1 (mA)	L1-L2 (mA)	L1-L3 (mA)	L2-L3 (mA)	L1-N (mA)	L2-N (mA)	L3-N (mA)
Test value	Three phase!	Three phase!	Three phase!	Three phase!	-78,8	-87,0	-84,0
Testing at 60+/-5% Output Power							
Phases	L1-L1 (mA)	L1-L2 (mA)	L1-L3 (mA)	L2-L3 (mA)	L1-N (mA)	L2-N (mA)	L3-N (mA)
Test value	Three phase!	Three phase!	Three phase!	Three phase!	-80,0	-92,0	-93,0
Testing at 100+/-5% Output Power							
Phases	L1-L1 (mA)	L1-L2 (mA)	L1-L3 (mA)	L2-L3 (mA)	L1-N (mA)	L2-N (mA)	L3-N (mA)
Test value	Three phase!	Three phase!	Three phase!	Three phase!	-77,0	-98,0	-89,0

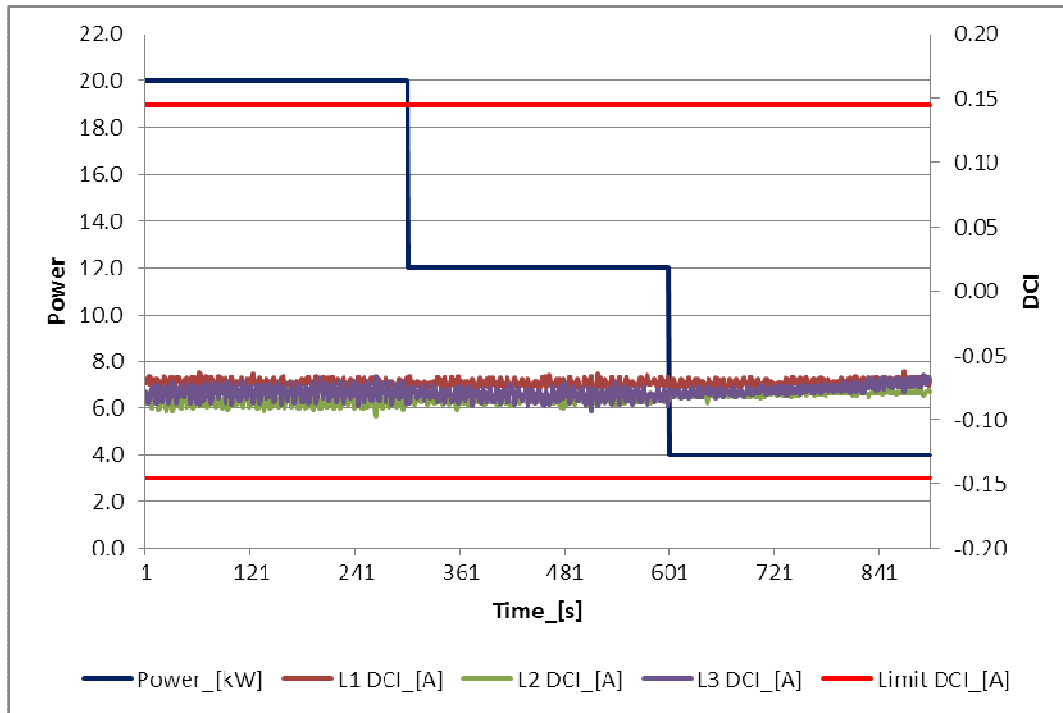

Note:

In the case of a single-phase inverter: not exceed 0.5% of the inverter's rated current or 5 mA, whichever is the greater.

In the case of a three-phase inverter: shall not exceed 0.5% of the inverter's per-phase rated current or 5 mA, whichever is the greater.

The tests had been performed on the SOFAR 10000TL-Sx Series and SOFAR 20000TL-Sx Series are valid for the SOFAR 15000TL-Sx Series and SOFAR 17000TL-Sx Series, since it is similar in hardware and just power derated by software.

5.10 Current balance for three-phase inverters						P
Setting values	PF cos $\varphi = 1$			Rated output current: 28,986 A		
Test value	L1	L2	L3	L1 – L2	L2 – L3	L3 – L1
100% of rated current	28,754	28,891	28,839	-0,136	0,052	0,085
	28,755	28,891	28,834	-0,136	0,057	0,079
	28,756	28,890	28,833	-0,134	0,057	0,077
	28,756	28,892	28,830	-0,137	0,062	0,074
	28,758	28,887	28,831	-0,130	0,056	0,074
Limit [A]: 5% of rated current	1,449A					
<p>Note:</p> <p>The a.c. output current for each phase for three-phase balanced current shall be within 5% of the measured value of the other phases at rated current when injected into a balanced three phase voltage.</p> <p>The tests had been performed on the SOFAR 20000TL-Sx Series is valid for the SOFAR 10000TL-Sx Series, SOFAR 15000TL-Sx Series and SOFAR 17000TL-Sx Series, since it is similar in hardware and just power derated by software.</p>						

6.2 Inverter demand response modes (DRMs) Appendix I Demand and power quality response					P
Mode	Requirement	Measurement			Result
		Real current (A)	Reactive current (A)	Switching Time (s)	
DRM 0	Operate the disconnection device	28,832	0,096	0,378	P
DRM 1	Do not consume power	N/A	N/A	N/A	N/A
DRM 2	Do not consume at more than 50% of rated power	N/A	N/A	N/A	N/A
DRM 1 and DRM 2		N/A	N/A	N/A	N/A
DRM 3	Do not consume at more than 75% of rated power AND Source reactive power if capable	N/A	N/A	N/A	N/A
DRM 2 and DRM 3		N/A	N/A	N/A	N/A
DRM 4	Increase power consumption (subject to constraints from other active DRMs)	N/A	N/A	N/A	N/A
DRM 5	Do not generate power	N/A	N/A	N/A	N/A
DRM 6	Do not generate at more than 50% of rated power	N/A	N/A	N/A	N/A
DRM 5 and DRM 6		N/A	N/A	N/A	N/A
DRM 7	Do not generate at more than 75% of rated power AND Sink reactive power if capable	N/A	N/A	N/A	N/A
DRM 6 and DRM 7		N/A	N/A	N/A	N/A
DRM 8	Increase power generation (subject to constraints from other active DRMs)	N/A	N/A	N/A	N/A
<p>Note: Switching time limit : 2s</p> <p>The tests had been performed on the SOFAR 20000TL-Sx Series is valid for the SOFAR 10000TL-Sx Series, SOFAR 15000TL-Sx Series and SOFAR 17000TL-Sx Series, since it is similar in hardware and just power derated by software.</p>					

6.3.2.2 Volt-watt response mode (Australia Default Setting)	P
--	----------

Test value	a) V1	b) V2	c) V3	d) V4
Voltage (V)	207,2	220,1	250,5	265,2
P (kW)	19,839	19,879	19,959	4,810
P/P _{rated} (%)	99,19	99,40	99,80	24,05

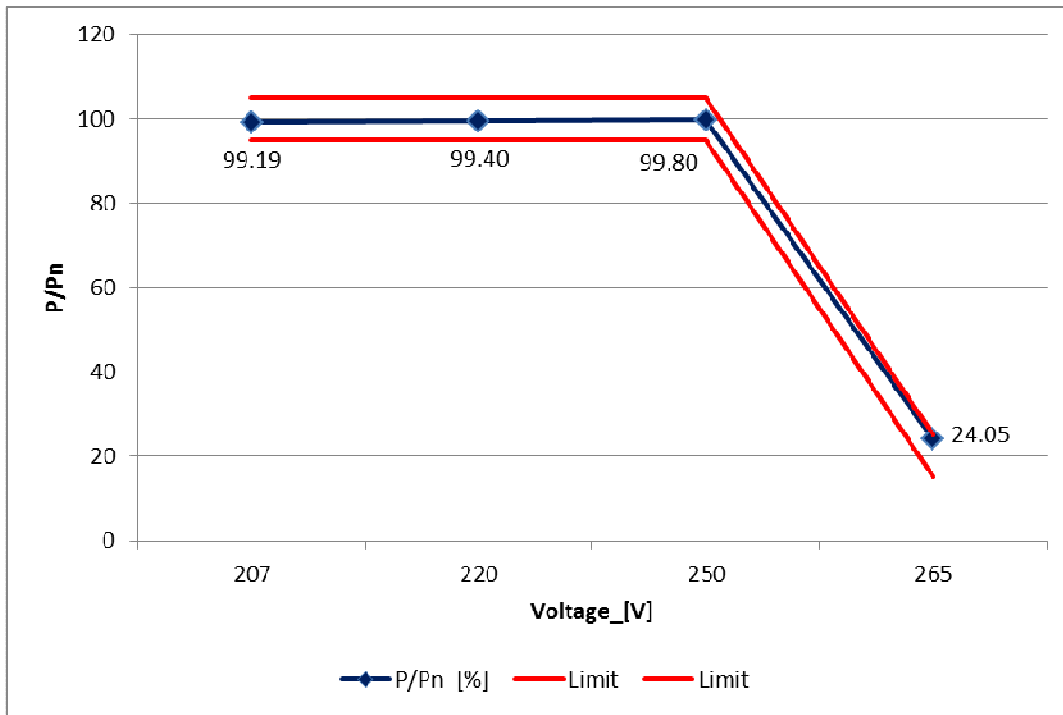

Note:

The tests had been performed on the SOFAR 20000TL-Sx Series is valid for the SOFAR 10000TL-Sx Series, SOFAR 15000TL-Sx Series and SOFAR 17000TL-Sx Series, since it is similar in hardware and just power derated by software.

6.3.2.2 Volt-watt response mode (New Zealand Default Setting)	P
--	----------

Test value	a) V1	b) V2	c) V3	d) V4
Voltage (V)	207,1	220,1	244,0	255,3
P (kW)	19,830	19,958	20,024	4,417
P/P _{rated} (%)	99,15	99,79	100,12	22,09

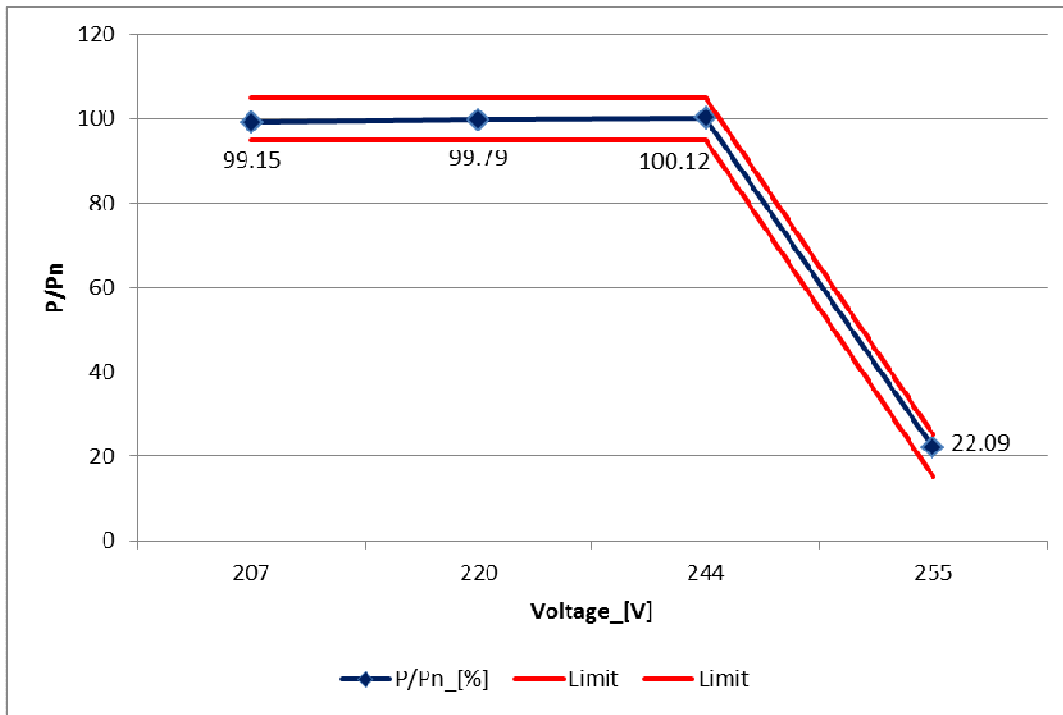

Note:

The tests had been performed on the SOFAR 20000TL-Sx Series is valid for the SOFAR 10000TL-Sx Series, SOFAR 15000TL-Sx Series and SOFAR 17000TL-Sx Series, since it is similar in hardware and just power derated by software.

6.3.3 Fixed power factor mode and reactive power mode										P
SOFAR 20000TL-Sx Series										
P/P _{rated} in %	10	25	30	40	50	60	70	80	90	100
Setting PF cosφ = 1										
U (V)	230,1	230,4	230,6	230,7	230,8	230,9	231,0	231,0	230,9	230,7
Power (W)	1,943	3,963	5,980	7,989	9,995	11,996	13,993	15,986	17,974	19,958
Reactive power (var)	0,103	0,102	0,101	0,099	0,093	0,087	0,080	0,072	0,064	0,054
Power factor	0,999	1,000	1,000	1,000	1,000	1,000	1,000	1,000	1,000	1,000
PF = 0,9 leading										
U (V)	230,0	230,0	230,0	229,9	229,8	229,6	229,6	229,7	229,9	229,9
Power (kW)	1,935	3,948	5,958	7,961	9,958	11,951	13,938	15,922	17,851	17,848
Reactive power (kVar)	-0,827	-1,805	-2,785	-3,765	-4,743	-5,720	-6,695	-7,672	-8,633	-8,675
Power factor	0,919	0,909	0,906	0,904	0,903	0,902	0,901	0,901	0,900	0,899
PF = 0,9 lagging										
U (V)	230,2	230,4	230,4	230,2	230,0	229,8	229,7	229,8	230,0	230,1
Power (kW)	1,945	3,961	5,974	7,978	9,979	11,973	13,963	15,951	17,934	18,411
Reactive power (kVar)	1,074	2,041	2,995	3,948	4,898	5,848	6,794	7,738	8,680	8,856
Power factor	0,875	0,899	0,894	0,896	0,898	0,899	0,899	0,900	0,900	0,901

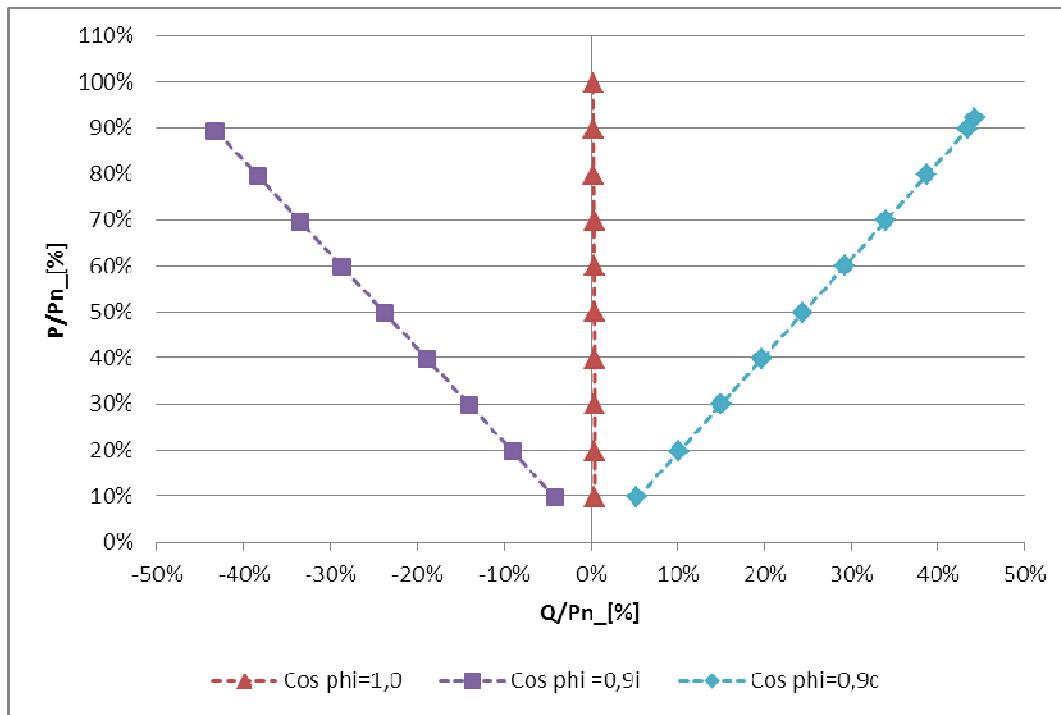

SOFAR 10000TL-Sx Series										
P/P _{rated} in %	10	25	30	40	50	60	70	80	90	100
Setting PF cosφ = 1										
U (V)	230,8	231,2	230,6	230,6	230,7	230,8	230,8	230,8	230,8	230,7
Power (W)	0,963	1,969	2,974	3,978	4,981	5,980	6,980	7,977	8,973	9,967
Reactive power (var)	-0,052	-0,053	-0,053	-0,052	-0,052	-0,052	-0,053	-0,053	-0,054	-0,056
Power factor	0,999	1,000	1,000	1,000	1,000	1,000	1,000	1,000	1,000	1,000
PF = 0,9 leading										
U (V)	229,9	230,0	230,1	230,1	230,1	230,1	230,0	229,9	229,9	229,8
Power (kW)	0,926	1,930	2,931	3,932	4,929	5,926	6,920	7,915	8,909	9,901
Reactive power (kVar)	-0,331	-0,813	-1,297	-1,783	-2,269	-2,755	-3,239	-3,722	-4,204	-4,686
Power factor	0,901	0,902	0,904	0,906	0,908	0,907	0,906	0,905	0,904	0,904
PF = 0,9 lagging										
U (V)	230,0	230,2	230,3	230,4	230,5	230,4	230,3	230,3	230,1	229,9
Power (kW)	0,931	1,938	2,940	3,940	4,939	5,936	6,931	7,928	8,923	9,914
Reactive power (kVar)	0,576	1,074	1,563	2,042	2,520	2,998	3,476	3,957	4,436	4,911
Power factor	0,881	0,895	0,893	0,898	0,891	0,893	0,894	0,895	0,895	0,896

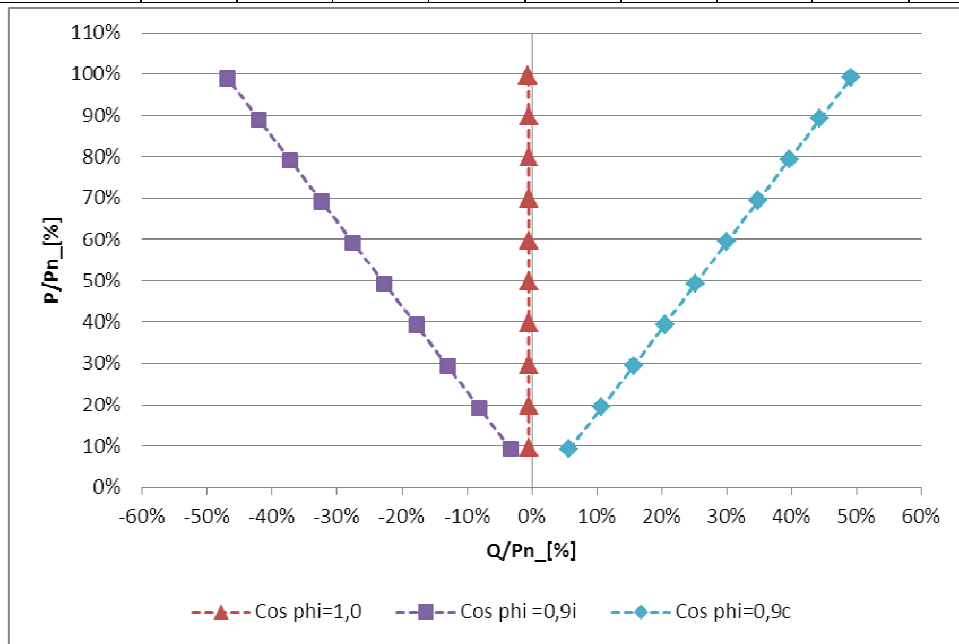

Note:

The grid-connected inverter of power plant type shall be evaluated.
 Each power-bin must be kept for at least 3 minute.
 If the inverter is capable of operating with reactive power mode, the maximum ratio of reactive power (vars) to rated apparent power should be 100%.
 If the inverter is capable of operating with fixed power factor mode, the minimum range of settings should be 0.8 leading to 0.8 lagging.
 The tests had been performed on the SOFAR 10000TL-Sx Series and SOFAR 20000TL-Sx Series are valid for the SOFAR 15000TL-Sx Series and SOFAR 17000TL-Sx Series, since it is similar in hardware and just power derated by software.

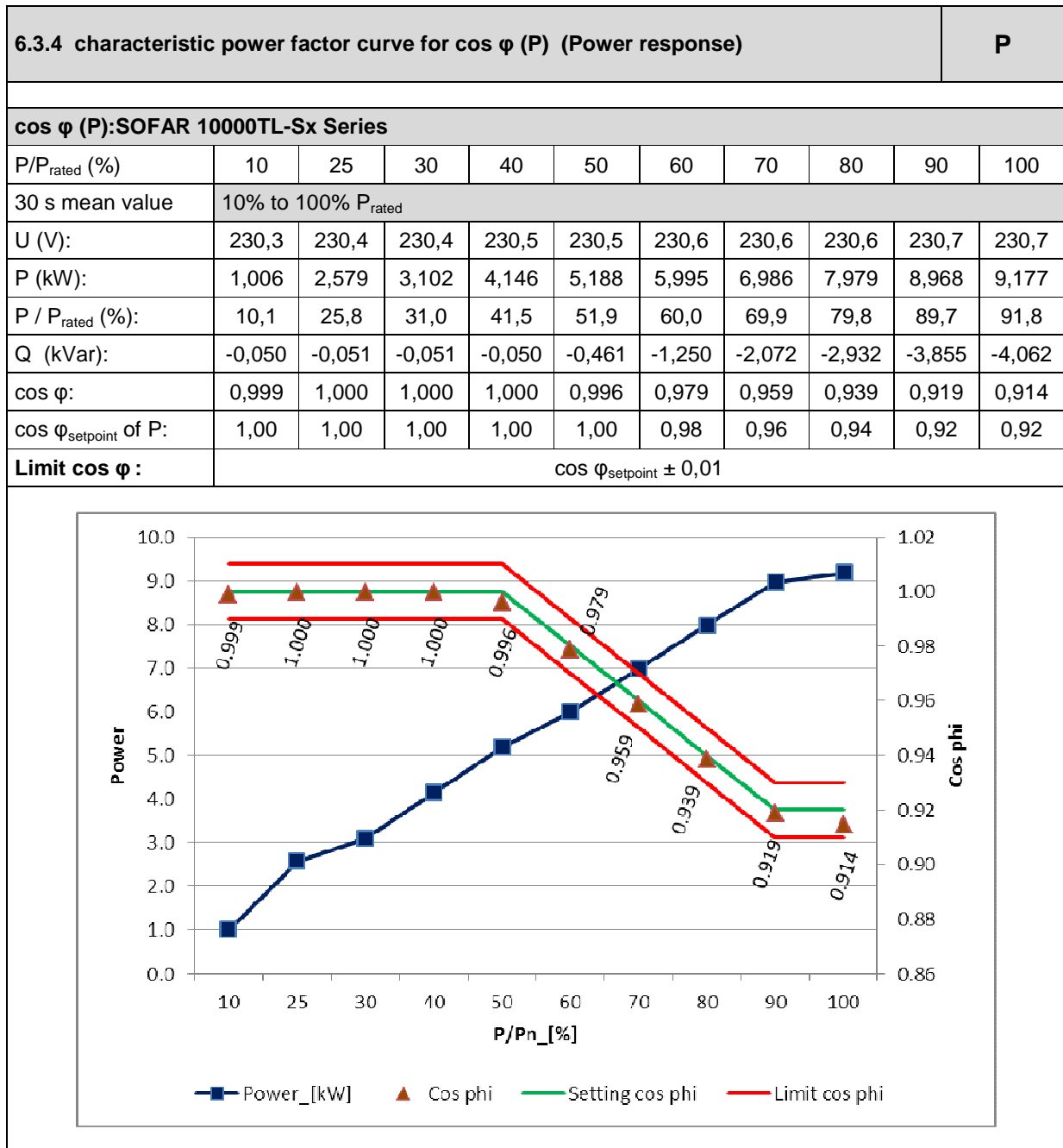

cos ϕ (P):SOFAR 20000TL-Sx Series										
P/P _{rated} (%)	10	25	30	40	50	60	70	80	90	100
30 s mean value	10% to 100% P _{rated}									
U (V):	229,5	229,6	229,6	229,8	229,9	229,9	230,0	230,1	230,1	230,1
P (kW):	1,939	4,971	5,980	7,992	10,002	11,995	13,984	15,966	17,938	18,158
P / P _{rated} (%):	9,7	24,9	29,9	40,0	50,0	60,0	69,9	79,8	89,7	90,8
Q (kVar):	0,100	0,100	0,100	0,100	0,000	-2,400	-4,100	-5,900	-7,700	-8,012
cos ϕ :	0,999	1,000	1,000	1,000	1,000	0,980	0,959	0,939	0,918	0,915
cos ϕ _{setpoint} of P:	1,00	1,00	1,00	1,00	1,00	0,98	0,96	0,94	0,92	0,92
Limit cos ϕ :	cos ϕ _{setpoint} \pm 0,01									

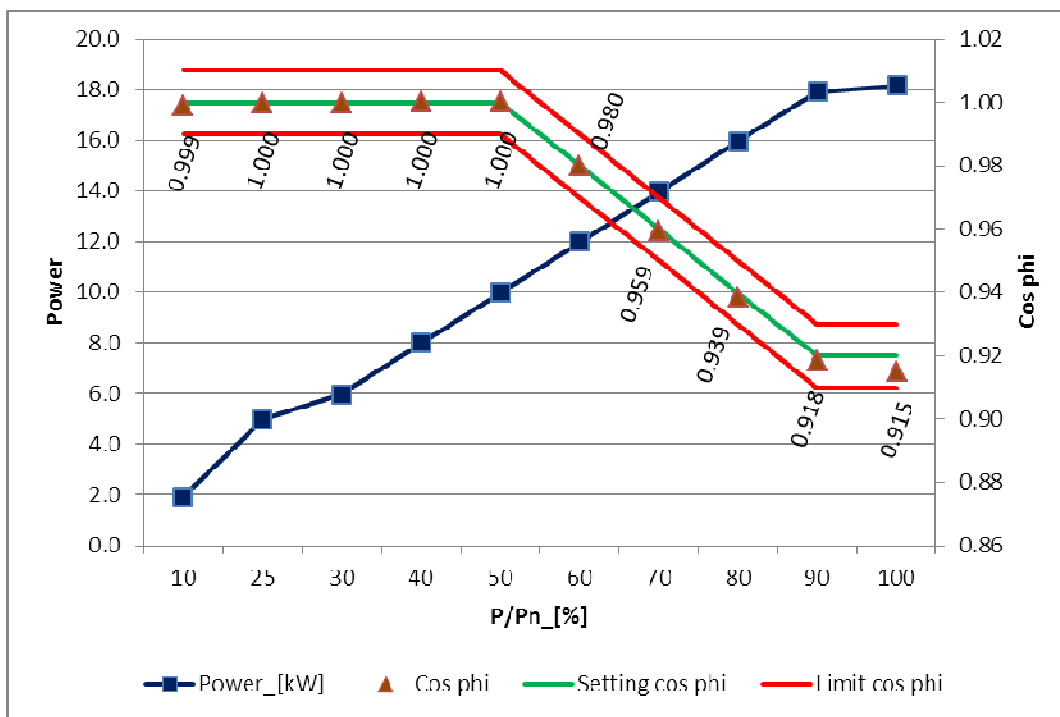

Note:

The response curve required for the cos ϕ (P) response should be defined within displacement power factor range of 0.9 leading to 0.9 lagging.

The tests had been performed on the SOFAR 10000TL-Sx Series and SOFAR 20000TL-Sx Series are valid for the SOFAR 15000TL-Sx Series and SOFAR 17000TL-Sx Series, since it is similar in hardware and just power derated by software.

6.3.5 Power rate limit	P
-------------------------------	----------

6.3.5.3.2 Test (a): Soft ramp up after connect or reconnect

Time measurement from 0% to 100% P_{rated} (min)	347 s
W_{Gra}	57 W
Limit W_{Gra} : (Default : 16,67%)	17,0%

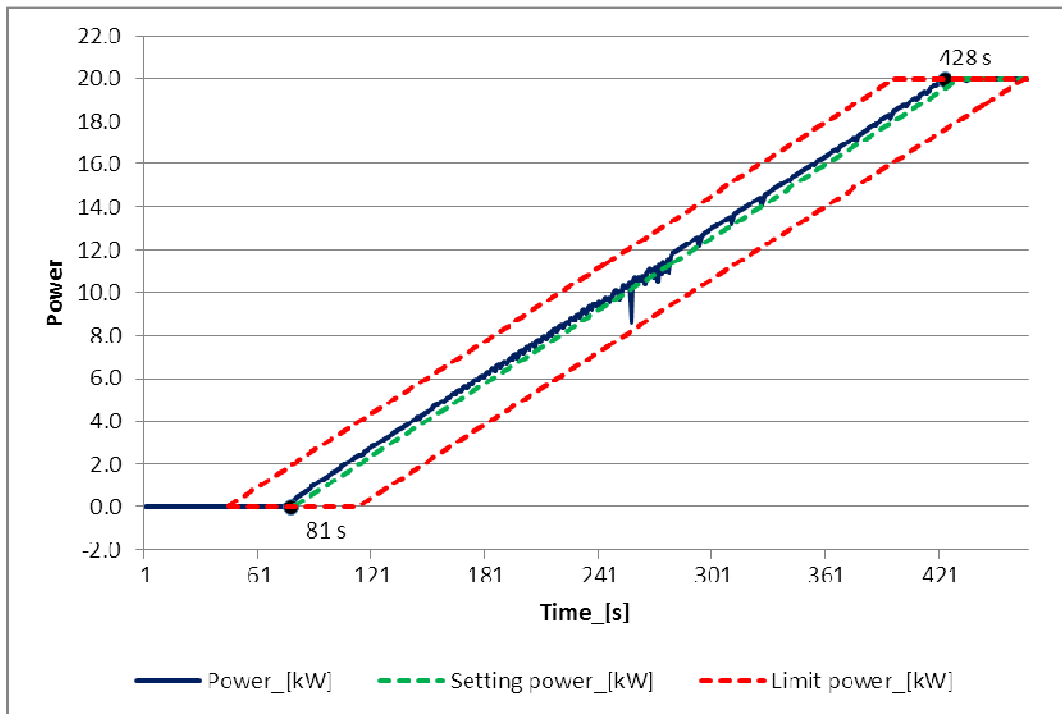

6.3.5.3.3 Test (b): Change in a.c. operation and control (DRM control only)

DRM mode	N/A	N/A
Power change (%)	N/A	N/A
Time measurement	N/A	N/A
W_{Gra}	N/A	N/A
Limit W_{Gra} : (Default : 16,67%)	N/A	N/A
N/A		

6.3.5.3.4 Test ©: Change in energy source operation (only for multiple mode inverters with energy storage)

DRM mode	N/A	N/A
Power change	N/A	N/A
Time measurement	N/A	N/A
W_{Gra}	N/A	N/A

Limit W_{Gra} : (Default : 16,67%)	N/A	N/A
N/A		
6.3.5.4 Nonlinearity of power rate limit changes		
DRM mode	DRM 0	N/A
Power change	Increase: __0__% to _100__%	N/A
Time measurement	347 s	N/A
W_{Gra}	57 W	N/A
Limit W_{Gra} : (Default : 16,67%)	17,0%	N/A
See table 6.3.5.3.2		
<p>Note: The tests had been performed on the SOFAR 20000TL-Sx Series is valid for the SOFAR 10000TL-Sx Series, SOFAR 15000TL-Sx Series and SOFAR 17000TL-Sx Series, since it is similar in hardware and just power derated by software.</p>		

7.3 Active anti-islanding protection
Appendix F Active anti-islanding test

F3 Test under load condition A = Light Electronic Load

P

Inverter output Power	Approx. Inverter power (W)	Time to trip (Average in Sec)	Disconnection Limit (in sec)
10+/-5%	1,890	0,316	2s
50+/-5%	9,844	0,374	2s
100+/-5%	19,911	0,352	2s

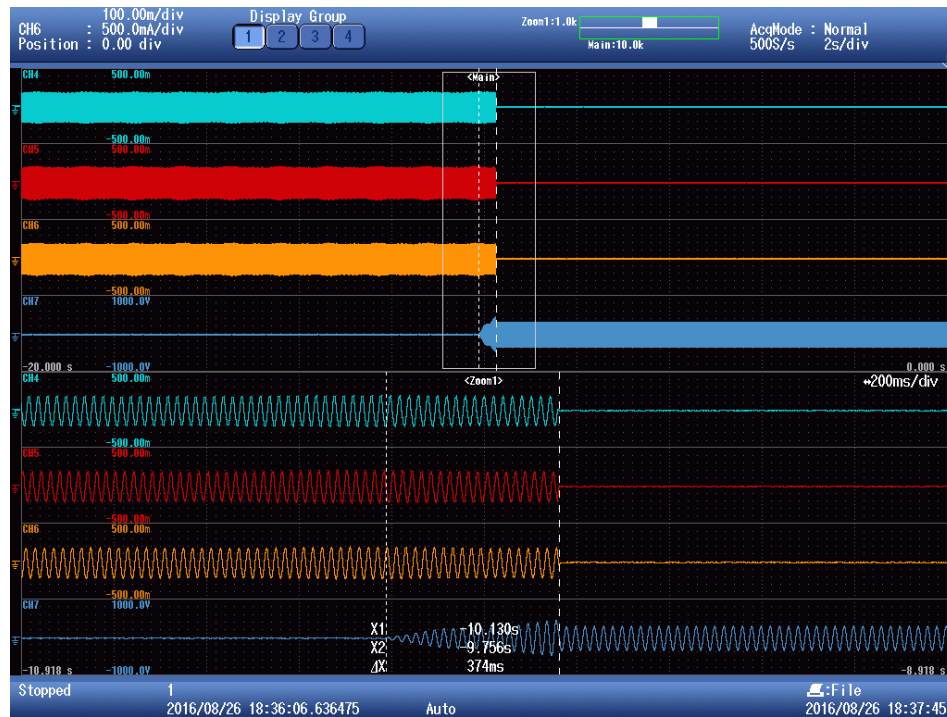

CH4,CH5, CH6: EUT output current; CH7: trip signal of switch off;

Light Electronic Load:

Test circuit according to AS 4777.2 Annex F (Figure F1 and F2). Grid voltage equal to nominal load. Via dc input control ac output power so that it equals to 10+/-5% of rated output. Switch S shall be opened and time interval for the inverter being disconnected shall be recorded. Same procedure for 50+/-5% and 100+/-5%.

The load of Figure F2 is used for the inverters with rated apparent power not more than 5kVA.

For other inverters, the resistor load of Figure 2 equal to 0,1% of rated apparent power.

The tests had been performed on the SOFAR 20000TL-Sx Series is valid for the SOFAR 10000TL-Sx Series, SOFAR 15000TL-Sx Series and SOFAR 17000TL-Sx Series, since it is similar in hardware and just power derated by software.

7.3 Active anti-islanding protection
Appendix F Active anti-islanding test

F4 Test under load condition B = Load match

P

Inverter output Power	Approx. Inverter power (kW)	Time to trip (Average in Sec)	Disconnection Limit (in sec)
10+/-5%	1,890	0,322	2s
50+/-5%	9,844	0,504	2s
100+/-5%	19,911	2s	

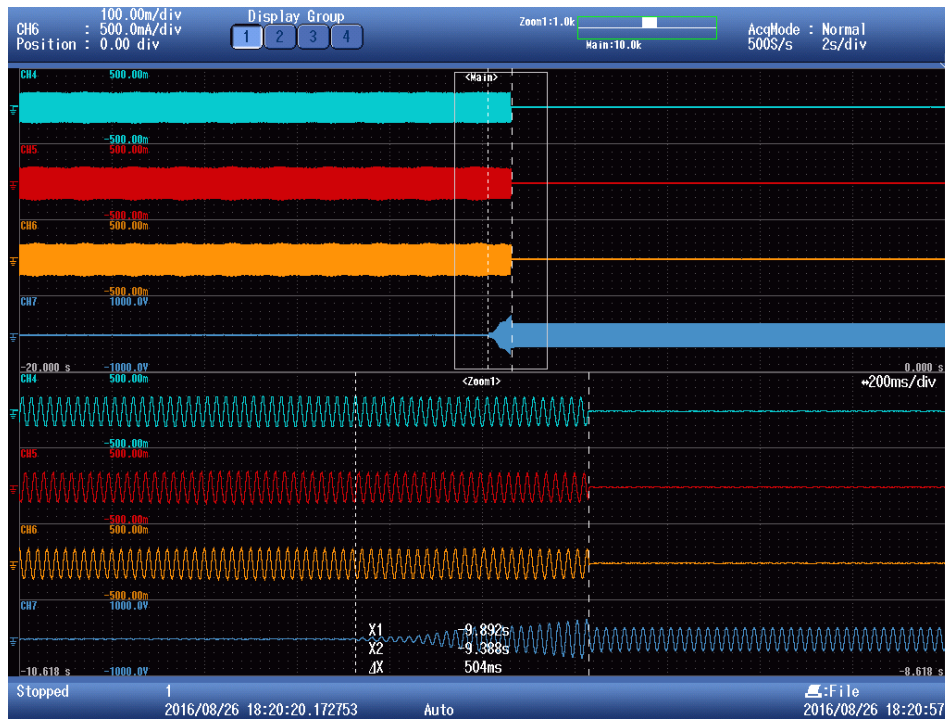

Load match:

Test circuit according to AS 4777.2 Annex F (Figure F1 and F3) Grid voltage equal to nominal load +/-5%, R shall match real power output, L and C shall draw reactive power according to Table F1. Via dc input control ac output power so that it equals to 10+/-5% of rated output. R shall be in- or decreased until resonant load matches real power output to within +/-5%. Inductive or capacitive load shall be adjusted until reactive power consumption matches the reactive power output of the inverter to within +/-5%. Switch S shall be opened and time interval of the inverter being disconnected shall be recorded. Same procedure for 50+/-5% and 100+/-5%.

The tests had been performed on the SOFAR 20000TL-Sx Series is valid for the SOFAR 10000TL-Sx Series, SOFAR 15000TL-Sx Series and SOFAR 17000TL-Sx Series, since it is similar in hardware and just power derated by software.

7.3 Active anti-islanding protection
Appendix F Active anti-islanding test

F5 Test under load condition B = Load match + 10%

P

Inverter output Power	Approx. Inverter power (kW)	Time to trip (Average in Sec)	Disconnection Limit (in sec)
10+/-5%	1,890	0,590	2s
50+/-5%	9,844	0,522	2s
100+/-5%	19,911	0,330	2s

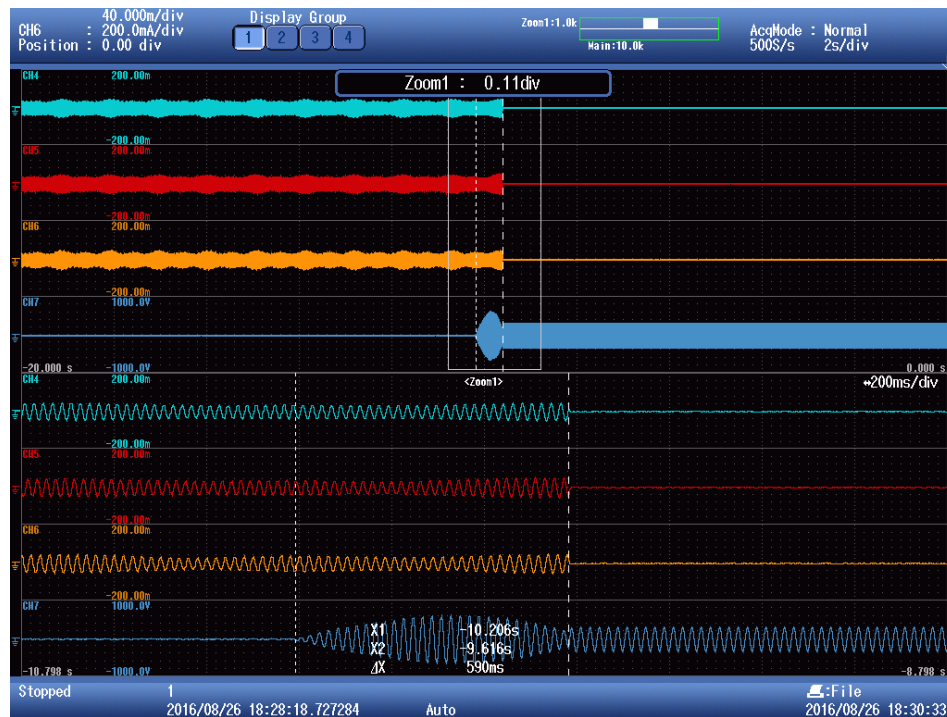

Load match + 10%:

Test circuit according to AS 4777.2 Annex F (Figure F1 and F3) Grid voltage equal to nominal load +/-5%, R shall match real power output, L and C shall draw reactive power according to Table F1. Via dc input control ac output power so that it equals to 10+/-5% of rated output. R shall be in- or decreased until resonant load matches real power output to within +/-5%. Inductive or capacitive load shall be adjusted until reactive power consumption matches the reactive power output of the inverter to within +/-5%. Switch S shall be opened and time interval of the inverter being disconnected shall be recorded. Same procedure for 50+/-5% and 100+/-5%.

The tests had been performed on the SOFAR 20000TL-Sx Series is valid for the SOFAR 10000TL-Sx Series, SOFAR 15000TL-Sx Series and SOFAR 17000TL-Sx Series, since it is similar in hardware and just power derated by software.

7.3 Active anti-islanding protection IEC 62116 Active anti-islanding test Load imbalance (real, reactive load) for test condition A (EUT output = 100%)									P
SOFAR 20000TL-Sx Series									
Test conditions		Frequency: 50+/-0,1Hz U _N =230+/-3Vac RLC consumes inverter real power within +/- 3% Distortion factor of chokes < 3% Quality =1							
Disconnection limit		0,5s							
No	P _{EUT} ¹⁾ (% of EUT rating)	Reactive load (% of Q _L in 6.1.d) 1)	P _{AC} ²⁾ (% of nominal)	Q _{AC} ³⁾ (% of nominal)	Run on Time (ms)	P _{EUT} (W)	Q _f	V _{DC}	Remarks ⁴⁾
1	100	100	0	0	532	6650	1,003	745	Test A at BL
4	100	100	-5	-5	77	6650	1,029	745	Test A at IB
5	100	100	-5	0	489	6650	1,056	745	Test A at IB
6	100	100	-5	+5	75	6650	1,082	745	Test A at IB
7	100	100	0	-5	79	6650	0,978	745	Test A at IB
8	100	100	0	+5	94	6650	1,028	745	Test A at IB
9	100	100	+5	-5	85	6650	0,931	745	Test A at IB
10	100	100	+5	0	513	6650	0,956	745	Test A at IB
11	100	100	+5	+5	80	6650	0,979	745	Test A at IB
Parameter at 0%		L= 25,25mH		R= 7,95Ω		C= 401,65μF			
Indicate additional shut down time included in above results. (Disconnection device operation time)								20ms	
<p>Note: Note for technologies which have a substantial shut down time this can be added to the 0.5 seconds in establishing that the trip occurred in less than 0.5s. Maximum shut down time could therefore be up to 1.0 seconds for these technologies. RLC is adjusted to min. +/-1% of the inverter rated output power</p> <p>1) P_{EUT}: EUT output power 2) P_{AC}: Real power flow at S1 in Figure 1. Positive means power from EUT to utility. Nominal is the 0 % test condition value. 3) Q_{AC}: Reactive power flow at S1 in Figure 1. Positive means power from EUT to utility. Nominal is the 0 % test condition value. 4) BL: Balance condition, IB: Imbalance condition. Condition A: EUT output power P_{EUT} = Maximum⁵⁾ EUT input voltage⁶⁾ = >90% of rated input voltage range 5) Maximum EUT output power condition should be achieved using the maximum allowable input power. Actual output power may exceed nominal rated output. 6) Based on EUT rated input operating range. For example, If range is between X volts and Y volts, 90 % of range = X + 0,9 × (Y – X). Y shall not exceed 0,8 × EUT maximum system voltage (i.e., maximum allowable array open circuit voltage). In any case, the EUT should not be operated outside of its allowable input voltage range.</p>									

The tests had been performed on the SOFAR 20000TL-Sx Series is valid for the SOFAR 10000TL-Sx Series, SOFAR 15000TL-Sx Series and SOFAR 17000TL-Sx Series, since it is similar in hardware and just power derated by software.

Disconnection at P_{AC} 0% and Q_{AC} 0% reactive load and 100% nominal power



7.3 Active anti-islanding protection IEC 62116 Active anti-islanding test Load imbalance (reactive load) for test condition B (EUT output = 50 % – 66 %)									P
SOFAR 20000TL-Sx Series									
Test conditions		Frequency: 50+/-0,1Hz $U_N=230\pm 3V_{ac}$ RLC consumes inverter real power within +/- 3% Distortion factor of chokes < 3% Quality =1							
Disconnection limit		0,5s							
No	$P_{EUT}^{1)}$ (% of EUT rating)	Reactive load (% of Q_L in 6.1.d) 1)	$P_{AC}^{2)}$ (% of nominal)	$Q_{AC}^{3)}$ (% of nominal)	Run on Time (ms)	P_{EUT} (W)	Qf	V_{DC}	Remarks ⁴⁾
12	66	66	0	-5	67	4260	0,977	525	Test B at IB
13	66	66	0	-4	86	4260	0,982	525	Test B at IB
14	66	66	0	-3	79	4260	0,988	525	Test B at IB
15	66	66	0	-2	87	4260	0,993	525	Test B at IB
16	66	66	0	-1	438	4260	0,998	525	Test B at IB
2	66	66	0	0	461	4260	1,003	525	Test B at BL
17	66	66	0	1	222	4260	1,008	525	Test B at IB
18	66	66	0	2	70	4260	1,013	525	Test B at IB
19	66	66	0	3	89	4260	1,018	525	Test B at IB
20	66	66	0	4	70	4260	1,023	525	Test B at IB
21	66	66	0	5	66	4260	1,027	525	Test B at IB
Parameter at 0%			L= 39,43mH		R= 12,42Ω		C= 257,11μF		
Indicate additional shut down time included in above results. (Disconnection device operation time)								20ms	
Note: RLC is adjusted to min. +/-1% of the inverter rated output power ¹⁾ P_{EUT} : EUT output power ²⁾ P_{AC} : Real power flow at S1 in Figure 1. Positive means power from EUT to utility. Nominal is the 0 % test condition value. ³⁾ Q_{AC} : Reactive power flow at S1 in Figure 1. Positive means power from EUT to utility. Nominal is the 0 % test condition value. ⁴⁾ BL: Balance condition, IB: Imbalance condition. Condition B: EUT output power $P_{EUT} = 50\% - 66\%$ of maximum EUT input voltage ⁵⁾ = 50 % of rated input voltage range, $\pm 10\%$ ⁵⁾ Based on EUT rated input operating range. For example, If range is between X volts and Y volts, 50 % of range = $X + 0,5 \times (Y - X)$. Y shall not exceed $0,8 \times$ EUT maximum system voltage (i.e., maximum allowable array open circuit voltage). In any case, the EUT should not be operated outside of its allowable input voltage range.									

The tests had been performed on the SOFAR 2000TL-Sx Series is valid for the SOFAR 1000TL-Sx Series, SOFAR 1500TL-Sx Series and SOFAR 1700TL-Sx Series, since it is similar in hardware and just power derated by software.

Disconnection at P_{AC} 0% and Q_{AC} 0% reactive load and 66% nominal power



7.3 Active anti-islanding protection IEC 62116 Active anti-islanding test Load imbalance (reactive load) for test condition C (EUT output = 25 % – 33 %)									P
SOFAR 20000TL-Sx Series									
Test conditions		Frequency: 50+/-0,1Hz $U_N=230+/-3V_{ac}$ RLC consumes inverter real power within +/- 3% Distortion factor of chokes < 3% Quality =1							
Disconnection limit		0,5s							
No	$P_{EUT}^{1)}$ (% of EUT rating)	Reactive load (% of Q_L in 6.1.d) 1)	$P_{AC}^{2)}$ (% of nominal)	$Q_{AC}^{3)}$ (% of nominal)	Run on Time (ms)	P_{EUT} (W)	Qf	V_{DC}	Remarks ⁴⁾
22	33	33	0	-5	69	2000	0,980	305	Test C at IB
23	33	33	0	-4	73	2000	0,985	305	Test C at IB
24	33	33	0	-3	69	2000	0,990	305	Test C at IB
25	33	33	0	-2	85	2000	0,995	305	Test C at IB
26	33	33	0	-1	161	2000	1,000	305	Test C at IB
3	33	33	0	0	462	2000	1,005	305	Test C at BL
27	33	33	0	1	374	2000	1,011	305	Test C at IB
28	33	33	0	2	162	2000	1,016	305	Test C at IB
29	33	33	0	3	97	2000	1,020	305	Test C at IB
30	33	33	0	4	76	2000	1,025	305	Test C at IB
31	33	33	0	5	71	2000	1,030	305	Test C at IB
Parameter at 0%		L= 83,77mH		R= 26,45Ω		C= 121,07μF			
Indicate additional shut down time included in above results. (Disconnection device operation time)								20ms	
<p>Note: RLC is adjusted to min. +/-1% of the inverter rated output power ¹⁾ P_{EUT}: EUT output power ²⁾ P_{AC}: Real power flow at S1 in Figure 1. Positive means power from EUT to utility. Nominal is the 0 % test condition value. ³⁾ Q_{AC}: Reactive power flow at S1 in Figure 1. Positive means power from EUT to utility. Nominal is the 0 % test condition value. ⁴⁾ BL: Balance condition, IB: Imbalance condition. Condition C: EUT output power $P_{EUT} = 25 \% - 33 \%$ ⁵⁾ of maximum EUT input voltage ⁶⁾ = <10 % of rated input voltage range ⁵⁾ Or minimum allowable EUT output level if greater than 33 %. ⁶⁾ Based on EUT rated input operating range. For example, If range is between X volts and Y volts, 10 % of range = $X + 0,1 \times (Y - X)$. Y shall not exceed $0,8 \times$ EUT maximum system voltage (i.e., maximum allowable array open circuit voltage). In any case, the EUT should not be operated outside of its allowable input voltage range.</p>									

The tests had been performed on the SOFAR 20000TL-Sx Series is valid for the SOFAR 10000TL-Sx Series, SOFAR 15000TL-Sx Series and SOFAR 17000TL-Sx Series, since it is similar in hardware and just power derated by software.

Disconnection at P_{AC} 0% and Q_{AC} 0% reactive load and 33% nominal power

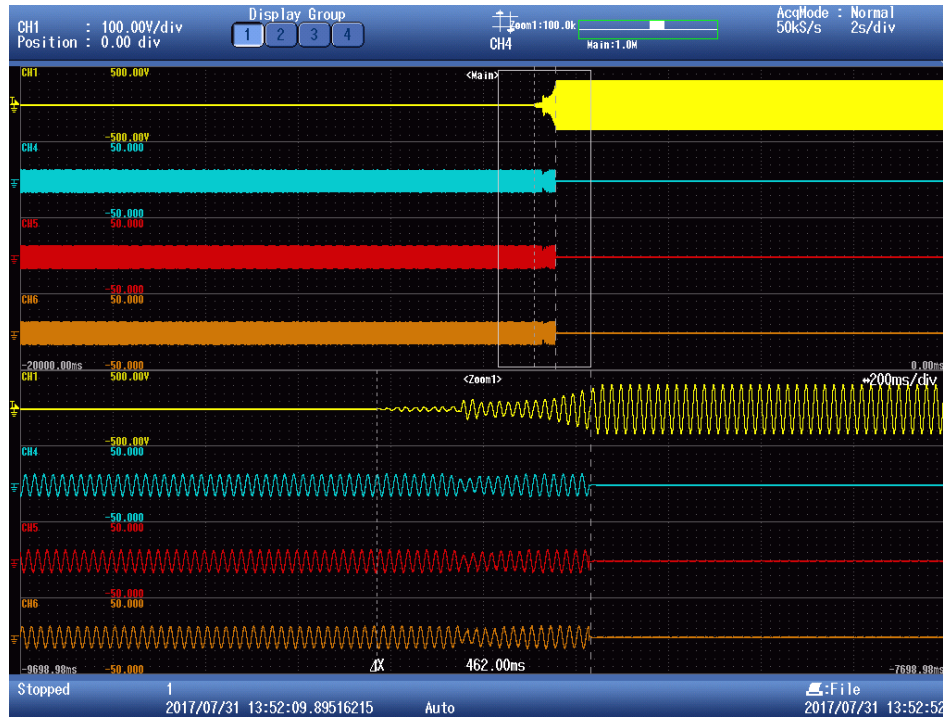

7.4 Voltage and frequency limits (passive anti-islanding protection) Appendix G2 Under- and over-voltage trip settings and reconnection test							P
L1 phase							
Output Current level: 50+/-5% rated current							
Test	Under Voltage (V)			Time to disconnect (s) (Trip delay 1s)			Time to reconnect (s)
Limit	< 180 V			<=2s			>=60s
Actual setting	180,0			2,0			60,0
Trip value	179,7	179,8	179,3	1,740	1,710	1,720	74,0
Test	Over Voltage 1 (V)			Time to disconnect (s) (Trip delay 1s)			Time to reconnect (s)
Limit	> 260 V			<=2s			>=60s
Actual setting	260,0			2,0			60,0
Trip value	260,2	260,6	260,4	1,710	1,710	1,710	74,0
Test	Over Voltage 2 (V)			Time to disconnect (s)			Time to reconnect (s)
Limit	> 265 V			<=0,2s			>=60s
Actual setting	265,0			0,2			60,0
Trip value	264,9	265,3	265,1	0,051	0,079	0,070	75,0
L2 phase							
Output Current level: 50+/-5% rated current							
Test	Under Voltage (V)			Time to disconnect (s) (Trip delay 1s)			Time to reconnect (s)
Limit	< 180 V			<=2s			>=60s
Actual setting	180,0			2,0			60,0
Trip value	180,2	179,9	179,7	1,710	1,710	1,710	75,0
Test	Over Voltage 1 (V)			Time to disconnect (s) (Trip delay 1s)			Time to reconnect (s)
Limit	> 260 V			<=2s			>=60s
Actual setting	260,0			2,0			60,0
Trip value	261,6	260,5	260,7	1,720	1,720	1,710	73,0
Test	Over Voltage 2 (V)			Time to disconnect (s)			Time to reconnect (s)
Limit	> 265 V			<=0,2s			>=60s
Actual setting	265,0			0,2			60,0
Trip value	266,1	265,7	265,3	0,089	0,097	0,094	73,0

L3 phase							
Output Current level: 50+/-5% rated current							
Test	Under Voltage (V)			Time to disconnect (s) (Trip delay 1s)			Time to reconnect (s)
Limit	< 180 V			<=2s			>=60s
Actual setting	180,0			2,0			60,0
Trip value	180,1	180,2	180,1	1,710	1,720	1,720	74,0
Test	Over Voltage 1 (V)			Time to disconnect (s) (Trip delay 1s)			Time to reconnect (s)
Limit	> 260 V			<=2s			>=60s
Actual setting	260,0			2,0			60,0
Trip value	260,4	260,2	260,1	1,710	1,710	1,710	75,0
Test	Over Voltage 2 (V)			Time to disconnect (s)			Time to reconnect (s)
Limit	> 265 V			<=0,2s			>=60s
Actual setting	265,0			0,2			60,0
Trip value	265,3	265,1	265,6	0,064	0,083	0,087	74,0
Note:							
Actual settings are the settings of the inverter. The Trip value the measured value. It has to be in the range of <u>+/- 2V</u> of the actual setting.							
The tests had been performed on the SOFAR 20000TL-Sx Series is valid for the SOFAR 10000TL-Sx Series, SOFAR 15000TL-Sx Series and SOFAR 17000TL-Sx Series, since it is similar in hardware and just power derated by software.							

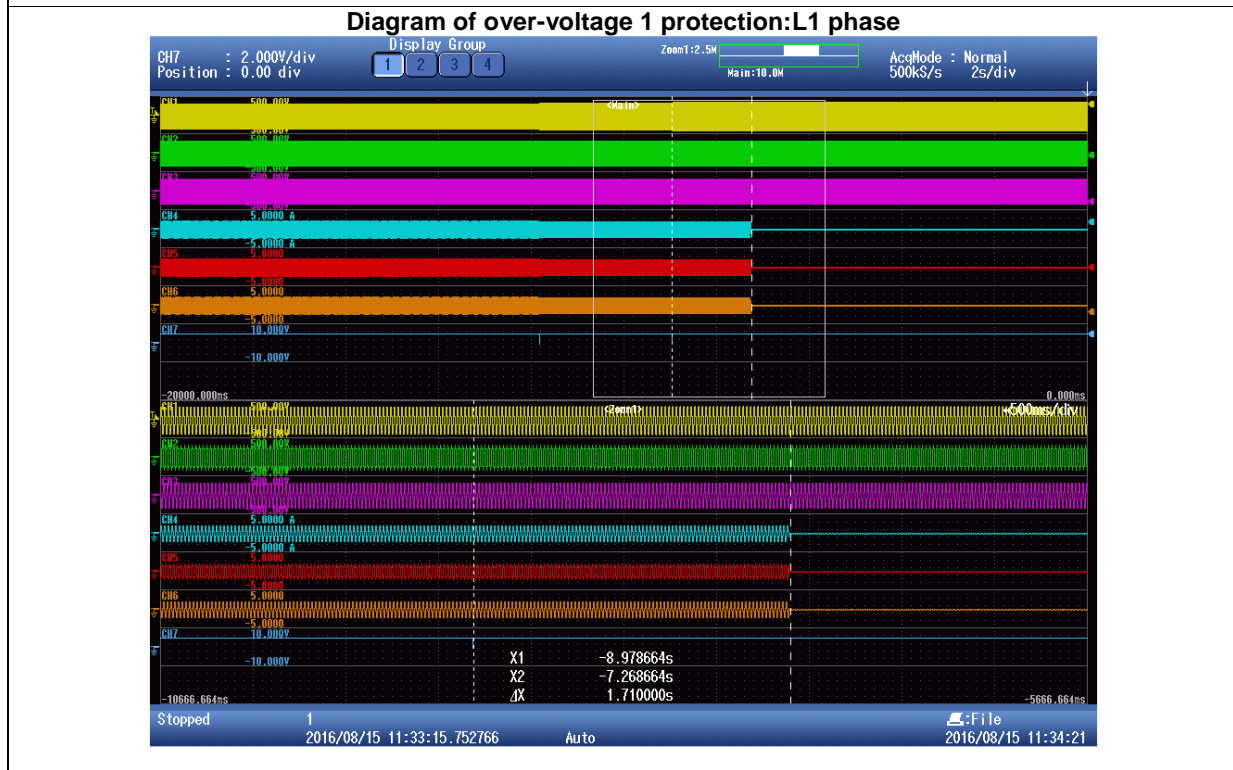
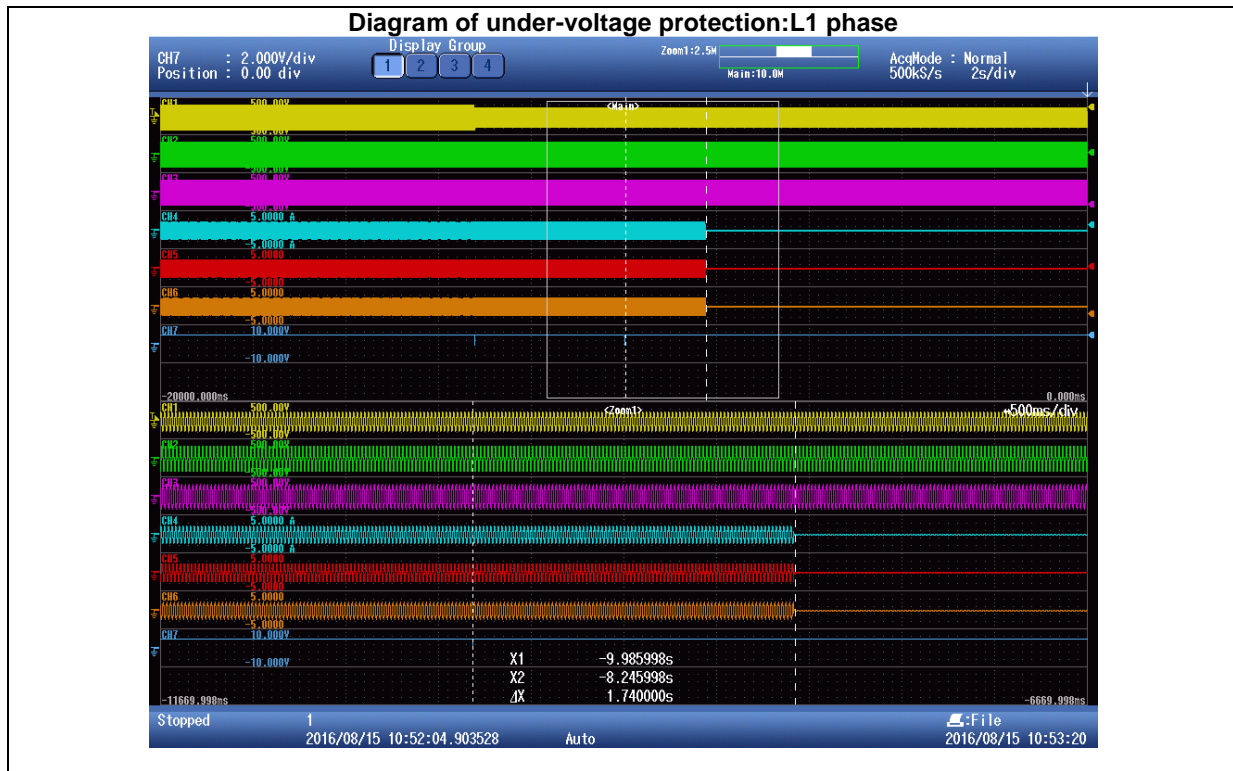

Note:

CH1,CH2, CH3: EUT output current;CH4,CH5, CH6: EUT output current; CH7: trip signal of AC source;

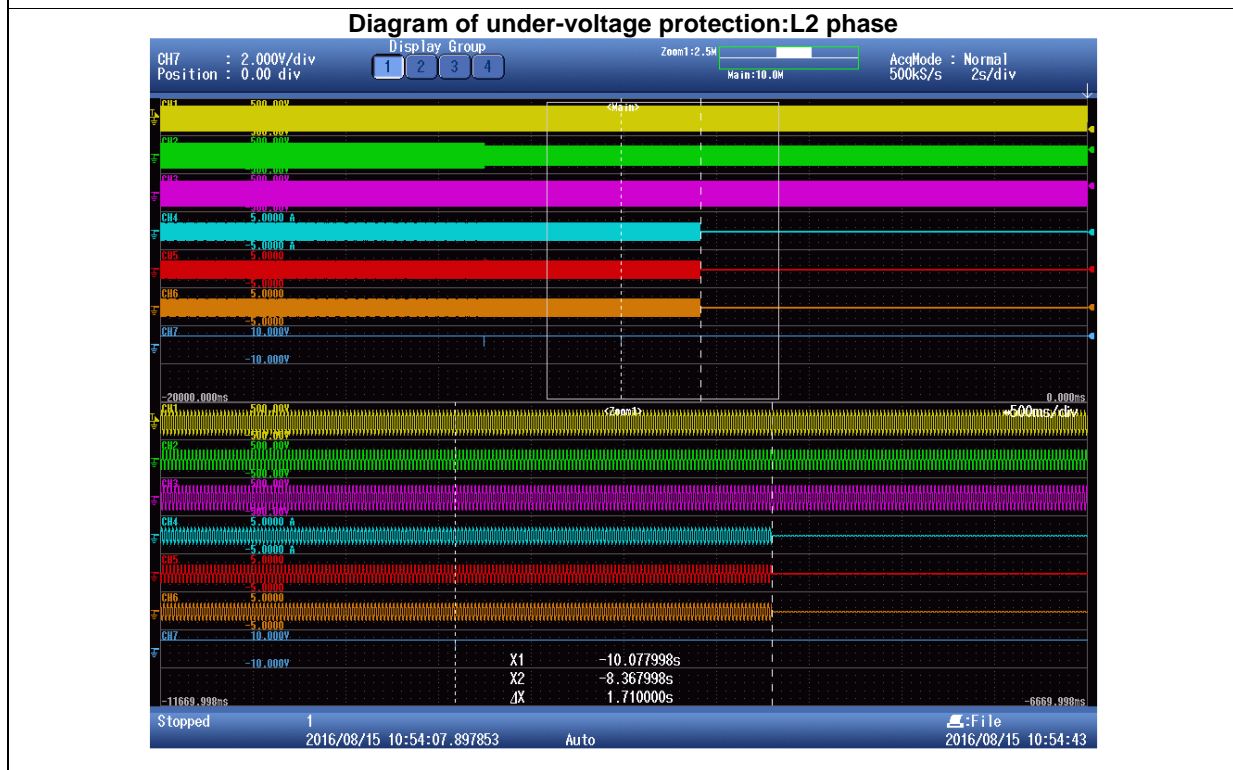
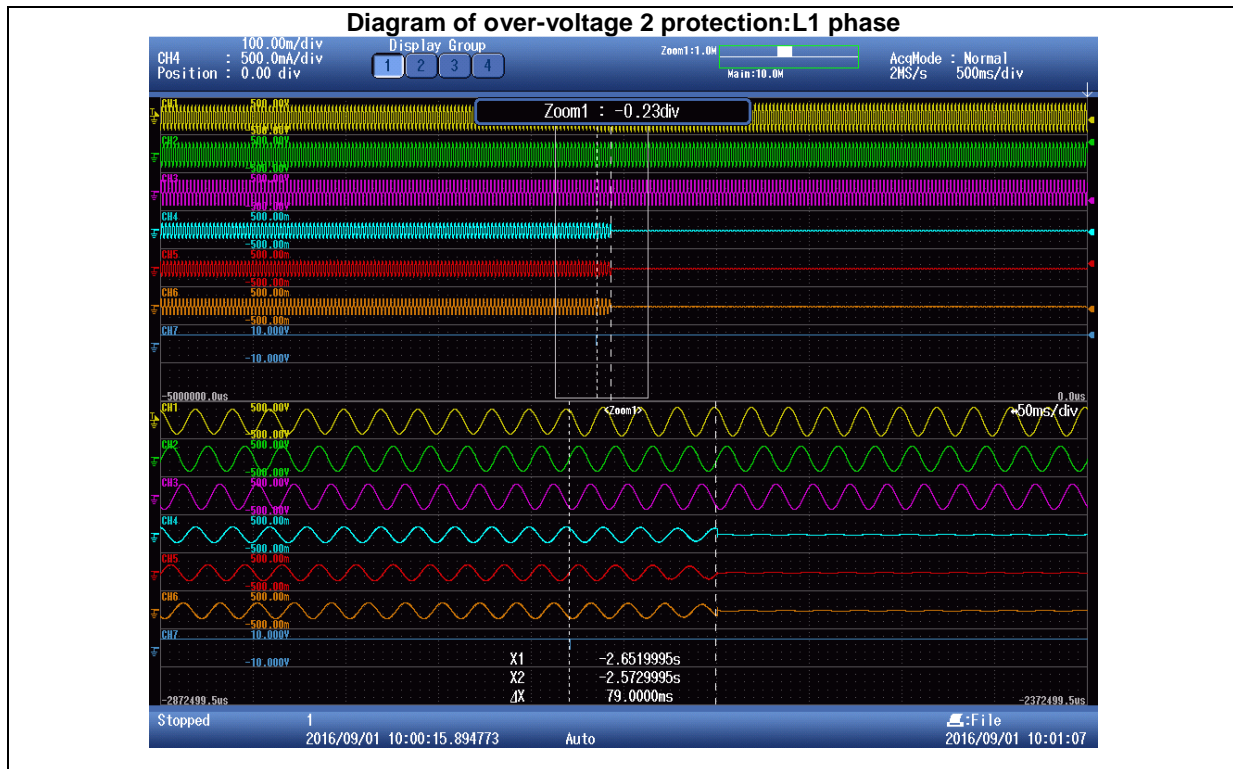

Note:
CH1,CH2, CH3: EUT output current;CH4,CH5, CH6: EUT output current; CH7: trip signal of AC source;

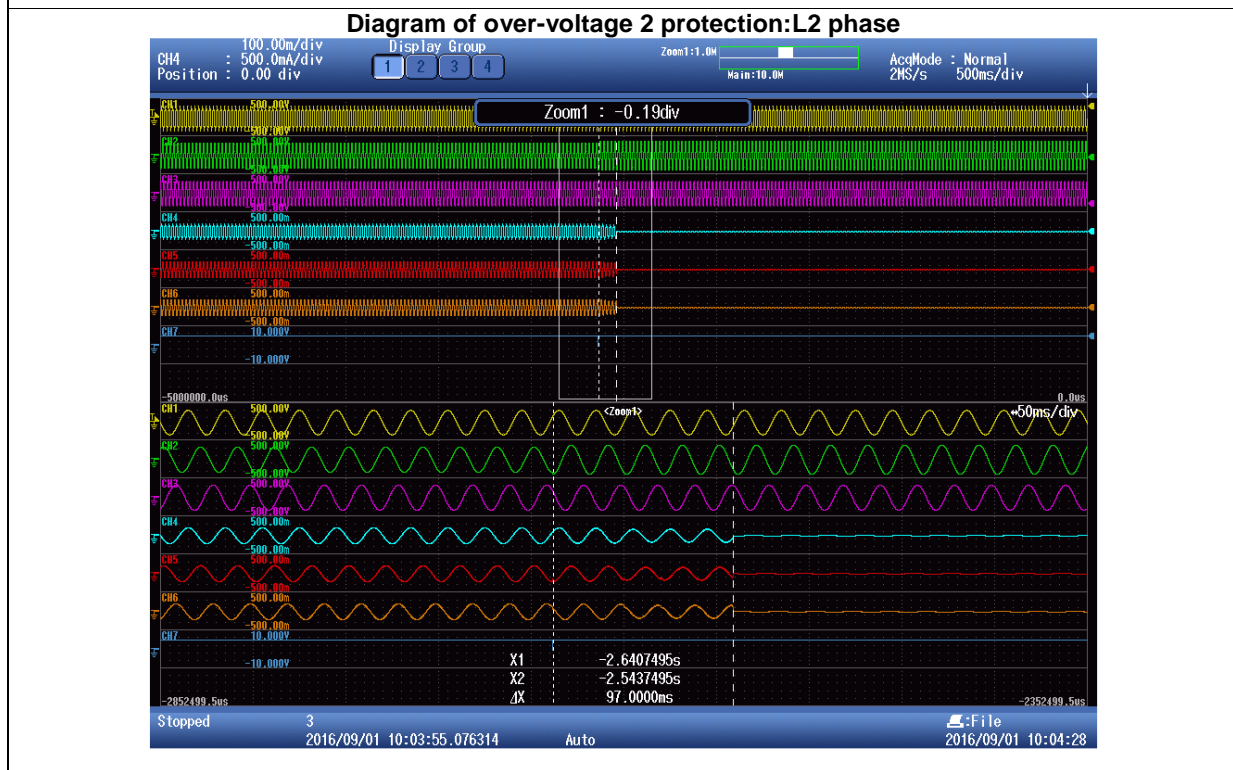
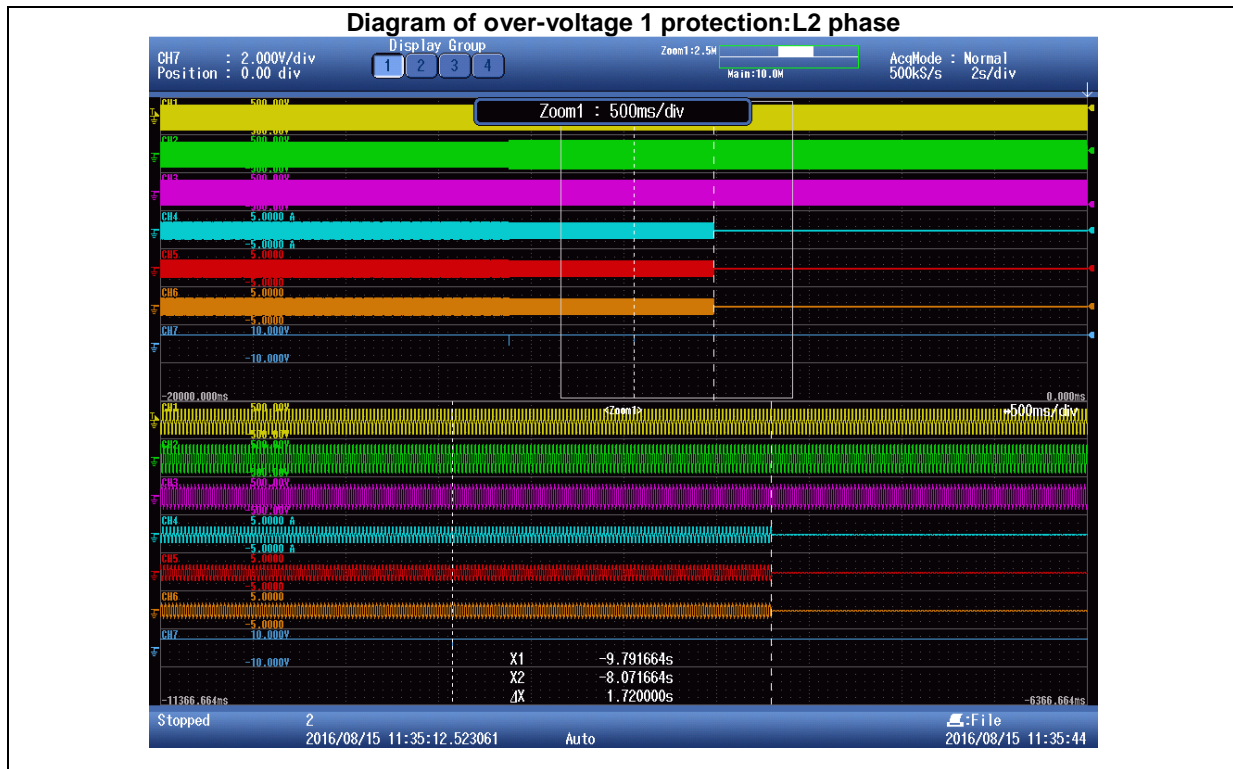

Note:
CH1,CH2, CH3: EUT output current;CH4,CH5, CH6: EUT output current; CH7: trip signal of AC source;

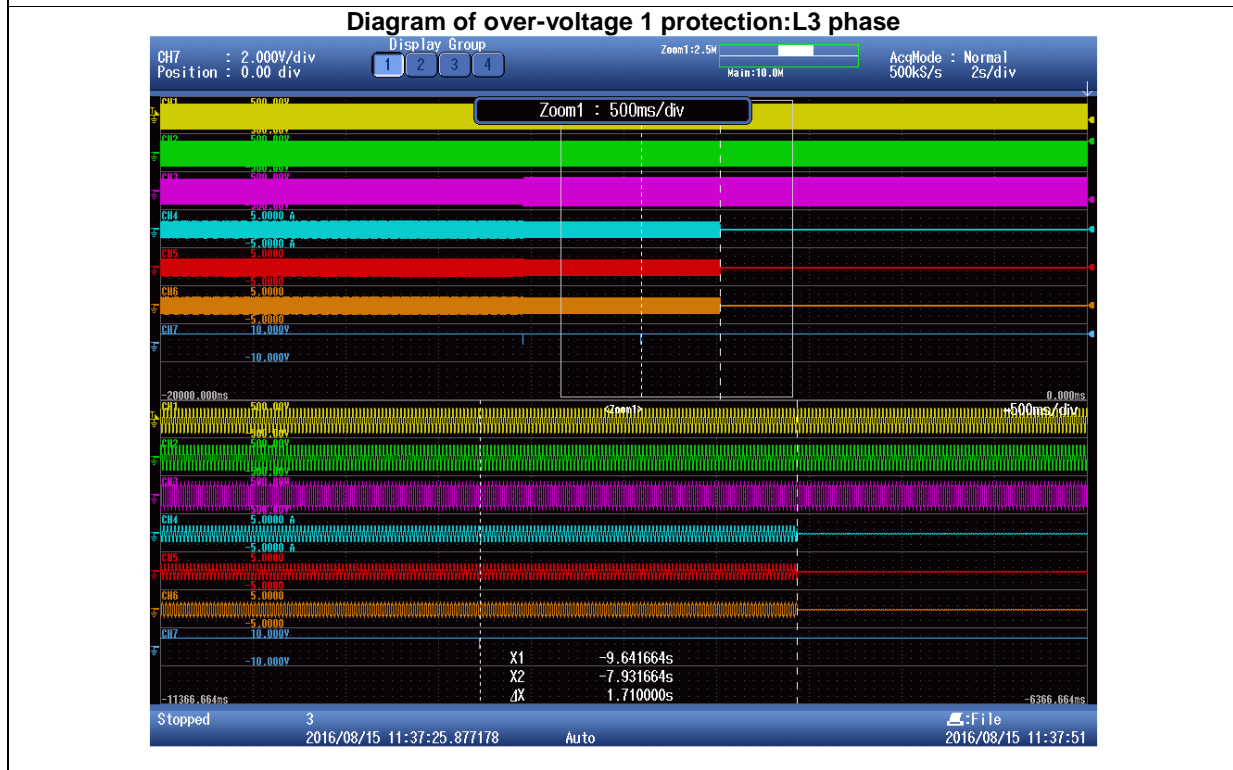
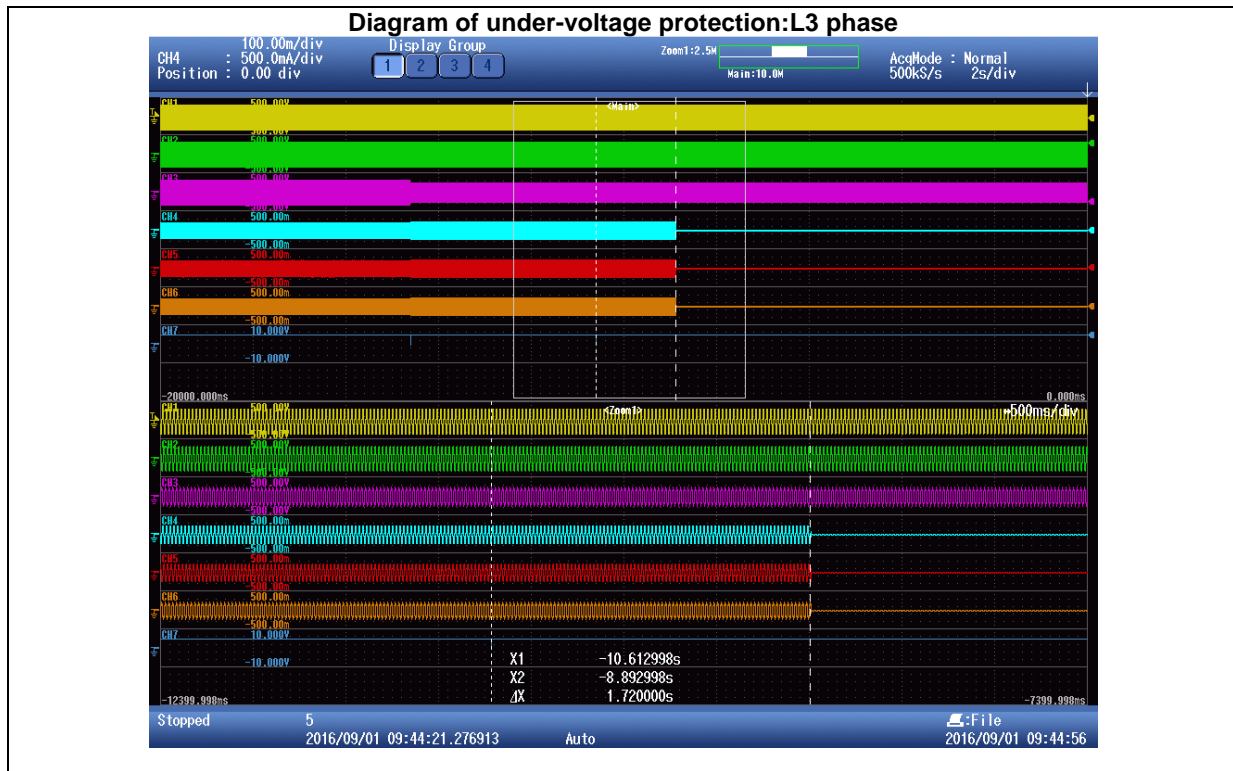

Note:
CH1,CH2, CH3: EUT output current;CH4,CH5, CH6: EUT output current; CH7: trip signal of AC source;

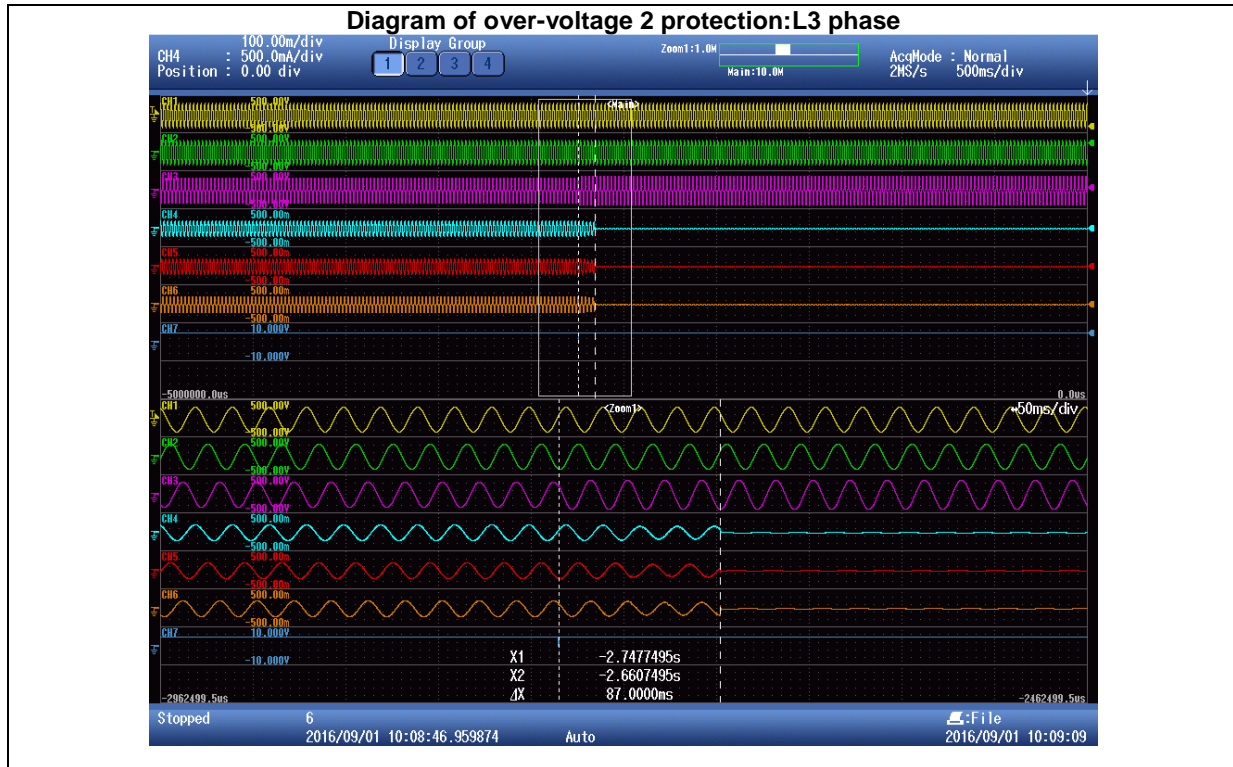

Note:
CH1,CH2, CH3: EUT output current;CH4,CH5, CH6: EUT output current; CH7: trip signal of AC source;

7.4 Voltage and frequency limits (passive anti-islanding protection) Appendix G3 Under- and over-frequency trip settings and reconnection test							P
Output Current level: 50+/-5% rated current or 10A (whichever is the lesser)							
Test	Under Frequency (Hz)			Time to disconnect (s) (Trip delay 1s)			Time to reconnect (s)
Australia Limit	≥47Hz			≤2s			≥60s
Actual setting	47,0			2,0			60,0
Trip value	47,00	47,00	47,00	1,720	1,710	1,720	74,0
Test	Under Frequency (Hz)			Time to disconnect (s) (Trip delay 1s)			Time to reconnect (s)
New Zealand Limit	≥45Hz			≤2s			≥60s
Actual setting	45,0			2,0			60,0
Trip value	45,00	45,00	45,00	1,730	1,710	1,730	75,0
Test	Over Frequency (Hz)			Time to disconnect (s)			Time to reconnect (s)
Limit	≤52Hz			≤0,2s			≥60s
Actual setting	52,0			0,2			60,0
Trip value	52,01	52,01	52,01	0,078	0,093	0,082	73,0
Note: Actual settings are the settings of the inverter. The trip value is the measured value. It has to be in the range of <u>+/- 0.1Hz</u> of the actual setting.							
The tests had been performed on the SOFAR 20000TL-Sx Series is valid for the SOFAR 10000TL-Sx Series, SOFAR 15000TL-Sx Series and SOFAR 17000TL-Sx Series, since it is similar in hardware and just power derated by software.							

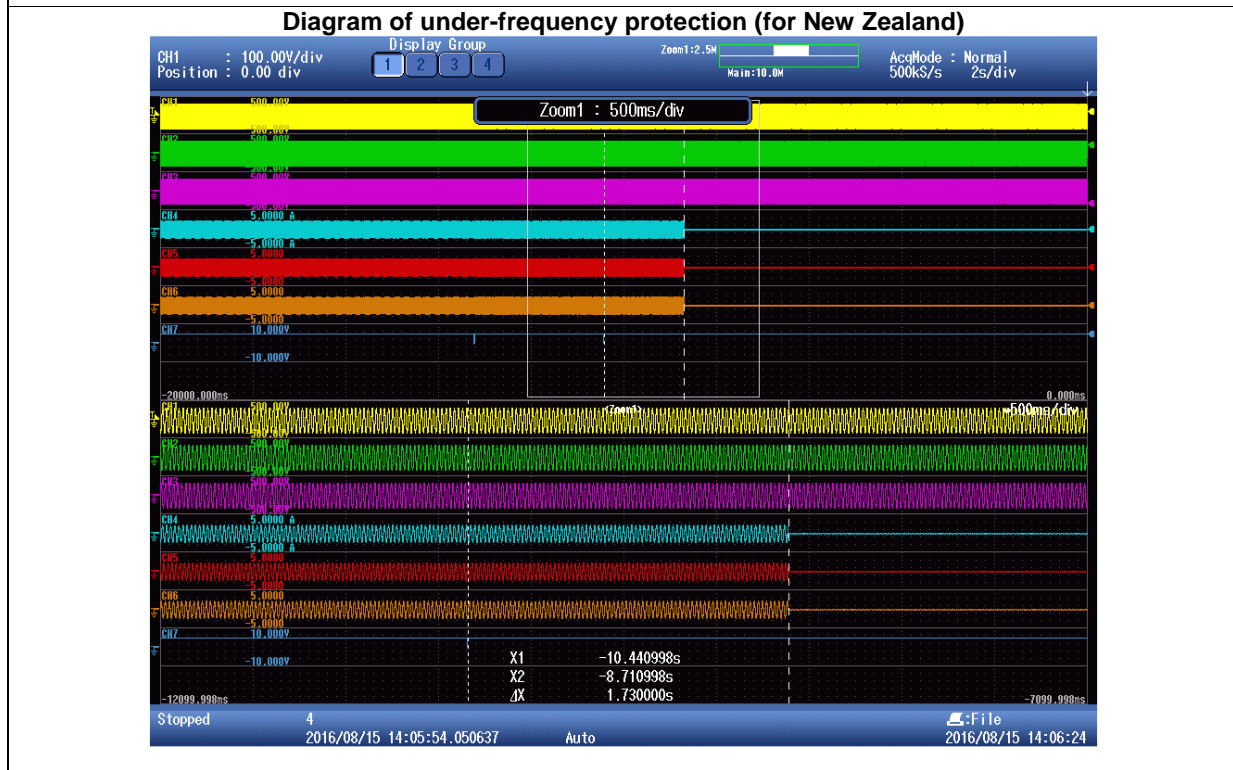
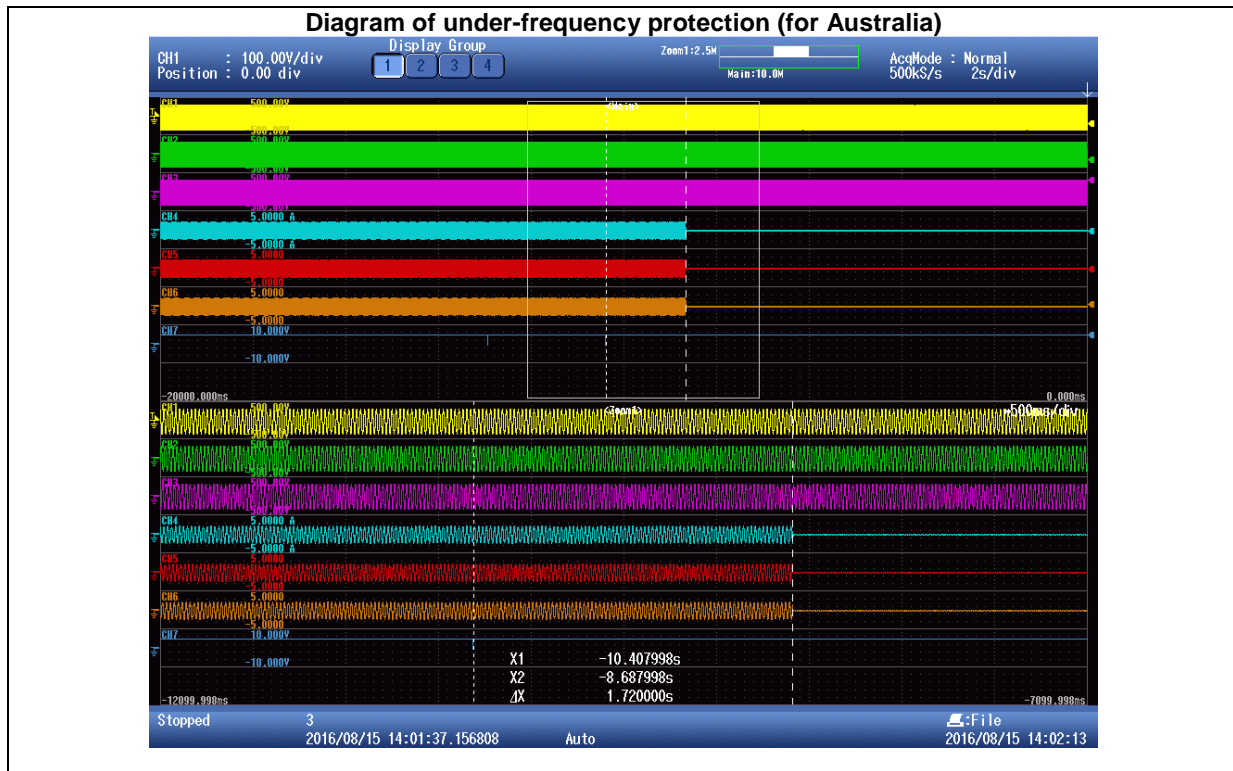

Note:
CH1,CH2, CH3: EUT output current;CH4,CH5, CH6: EUT output current; CH7: trip signal of AC source;

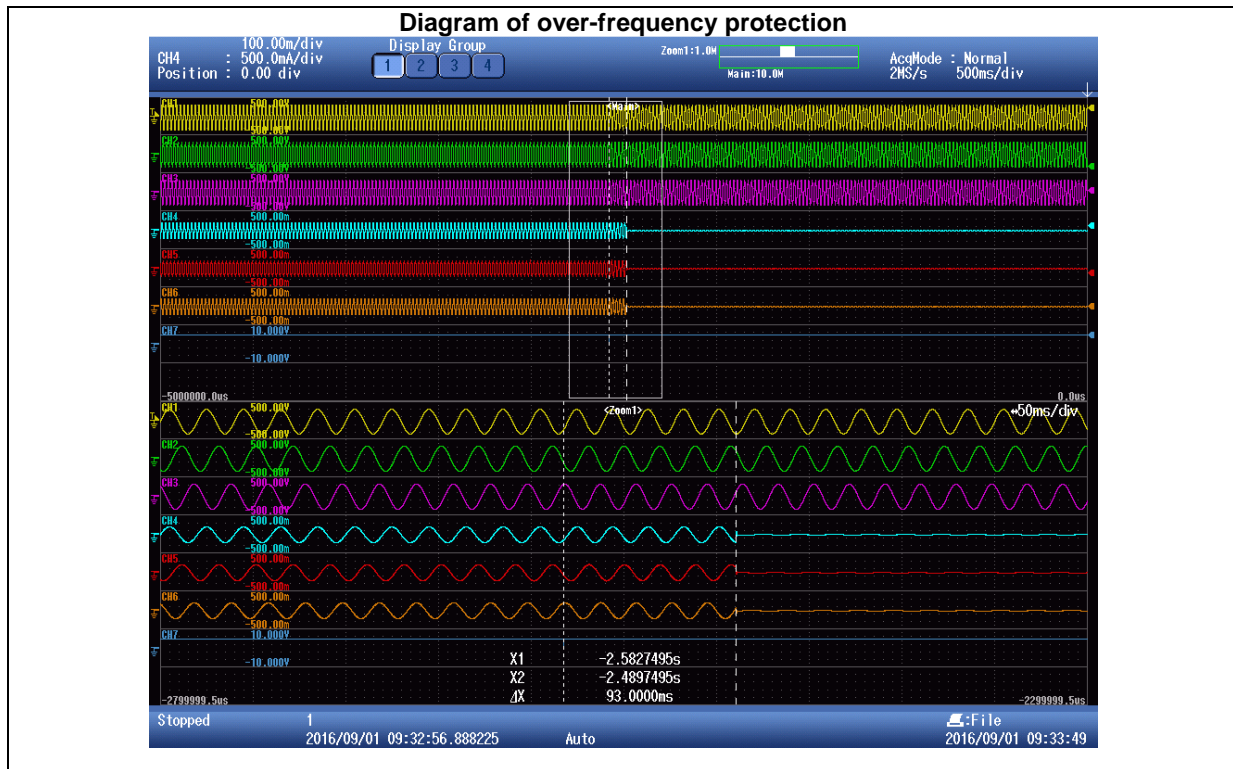

Note:
 CH1,CH2, CH3: EUT output current;CH4,CH5, CH6: EUT output current; CH7: trip signal of AC source;

7.5.2 Limits for sustained operation Appendix H2 Sustained operation for voltage variations Australia			P	
Output power level: 50+/-5% Apparent Power				
Setting values	Setting V _{nom_max} [V]	255,0		
	Setting T _{disconnection} [s]	25,0		
Test:				
Step 1. The voltage is set to V _{nom_max} – 1 V. Maintained for 5 min. Step 2. The voltage increase to V _{nom_max} + 1 V and proceeding 10 min. Step 3. The 10 min average voltage shall be recorded.				
a)	Average Voltage (V)		Limit	
	Phase 1	1 st time	255,3	1. Disconnection should take place. 2. Voltage within +/1 % of the set-point.
		2 nd time	255,3	
		3 rd time	255,3	
	Phase 2	1 st time	255,5	
		2 nd time	255,8	
		3 rd time	255,8	
	Phase 3	1 st time	255,8	
		2 nd time	255,5	
3 rd time		255,6		
b)	Disconnection time (s)		Limit	
	Phase 1	26,0	Disconnection time < 30s	
	Phase 2	22,0		
	Phase 3	26,0		
c)	Reconnection time (s)		Limit	
	Phase 1	74,0	Reconnection time > 60s	
	Phase 2	73,0		
	Phase 3	74,0		
Note: 1. The default set-point for V _{nom-max} shall be as follows: (a) In Australia: 255 V. (b) In New Zealand: 248 V. 2. The 10 min average value shall be compared against the limit V _{nom_max} at least every 3 s to determine when to disconnect. 3. The inverter shall operate the automatic disconnection device (see Clause 7.2) within 3 s when the average voltage for a 10 min period exceeds the V _{nom_max} . The tests had been performed on the SOFAR 20000TL-Sx Series is valid for the SOFAR 10000TL-Sx Series, SOFAR 15000TL-Sx Series and SOFAR 17000TL-Sx Series, since it is similar in hardware and just power derated by software.				

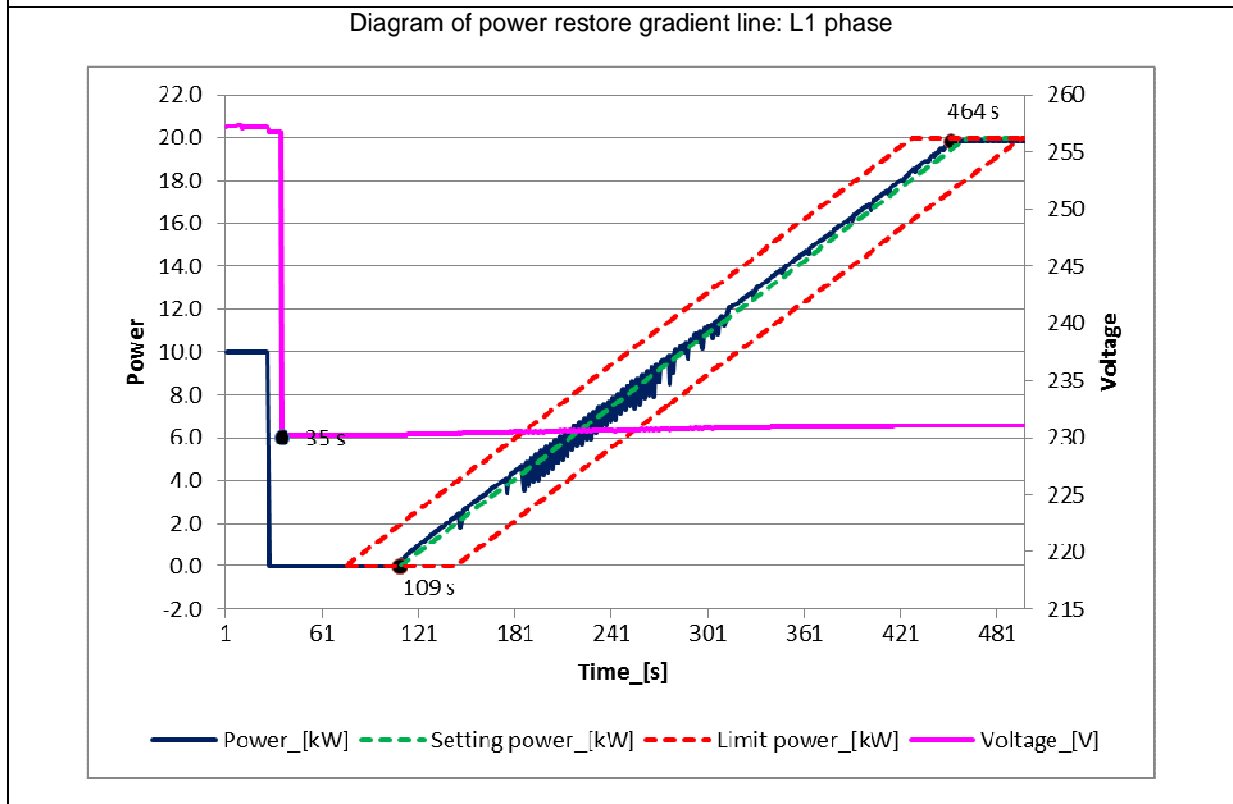
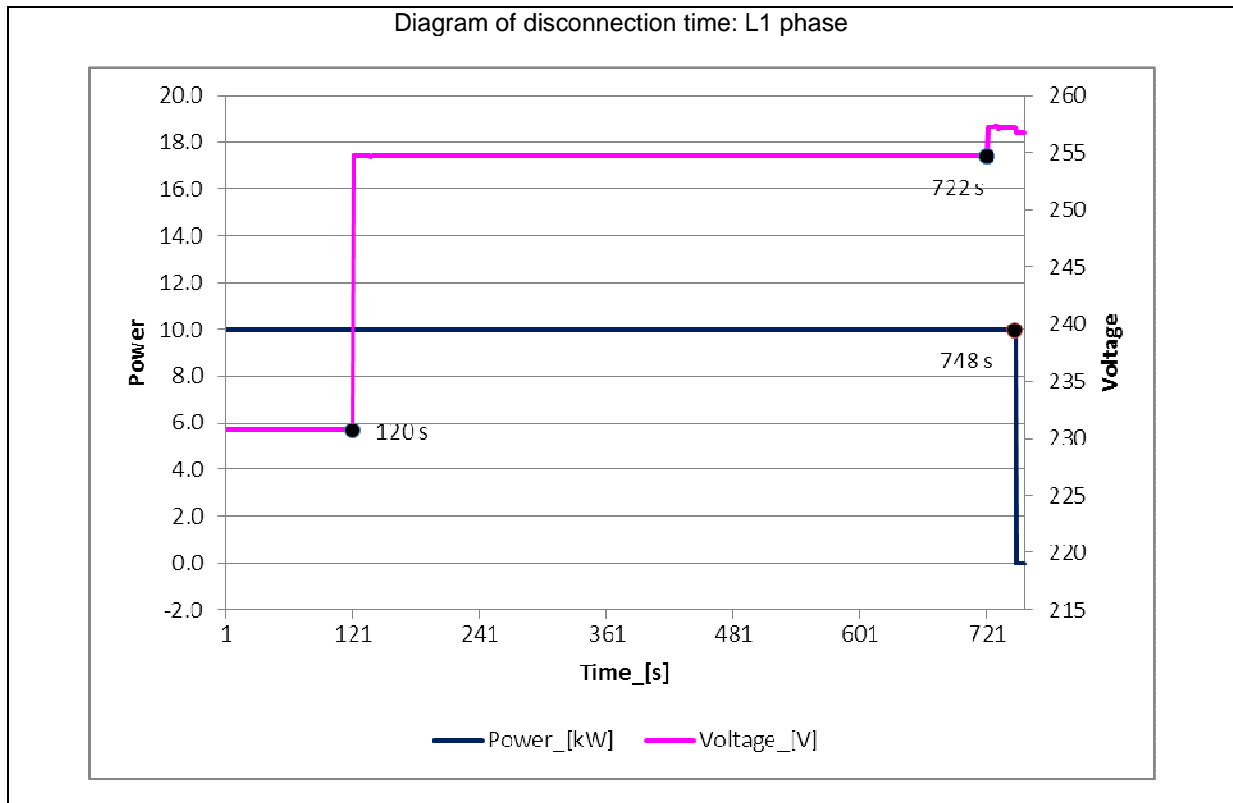

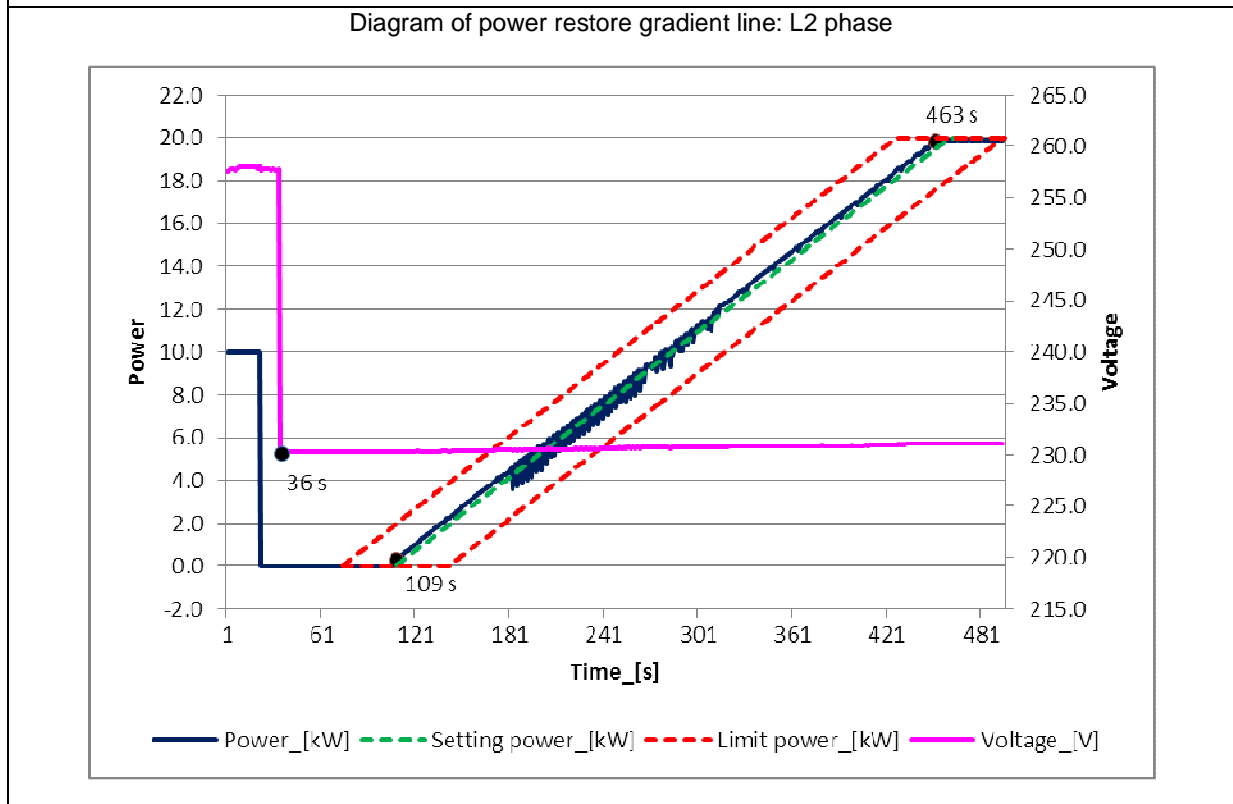
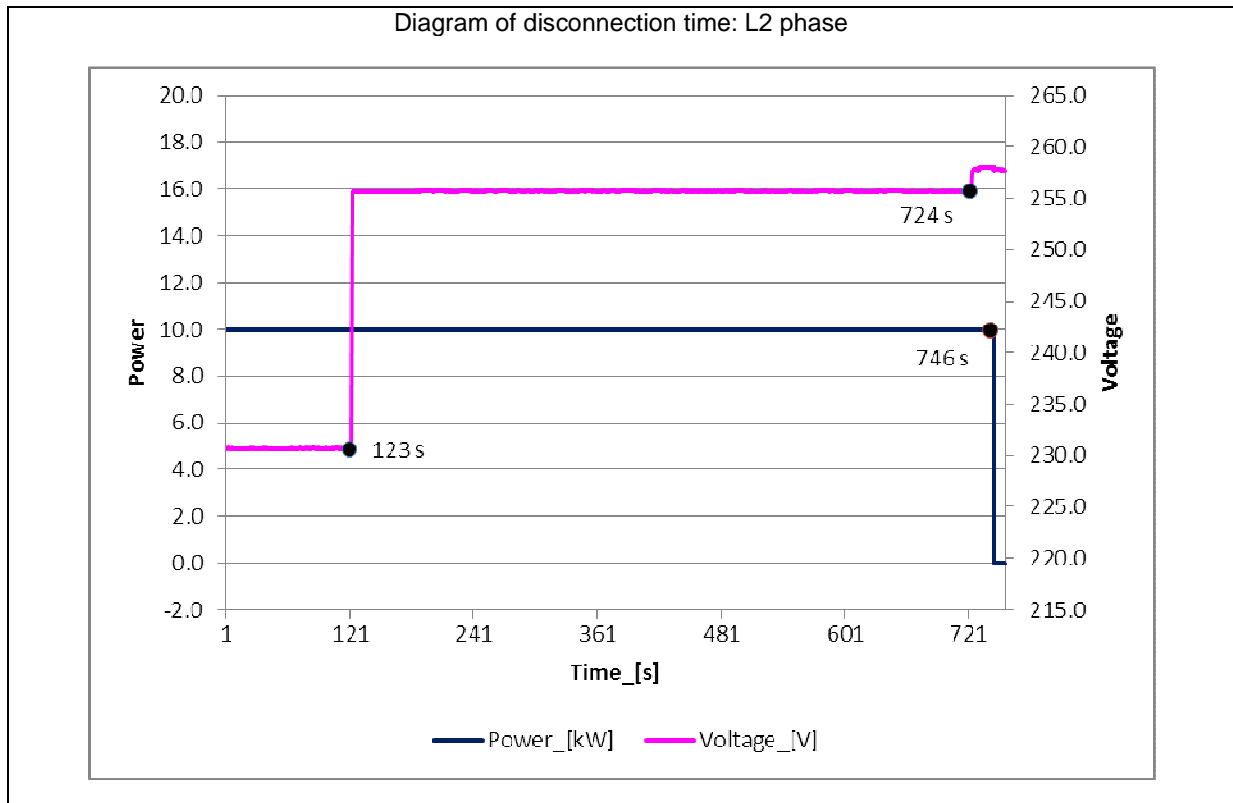

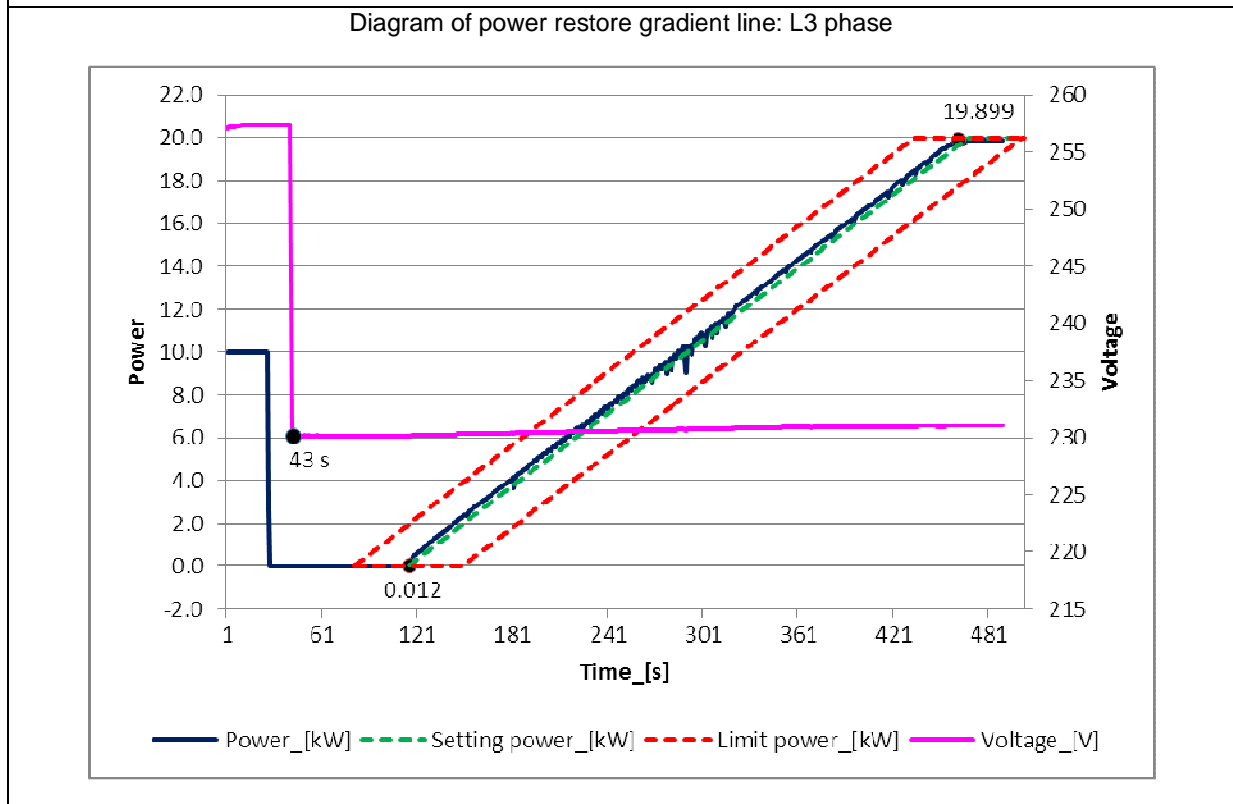
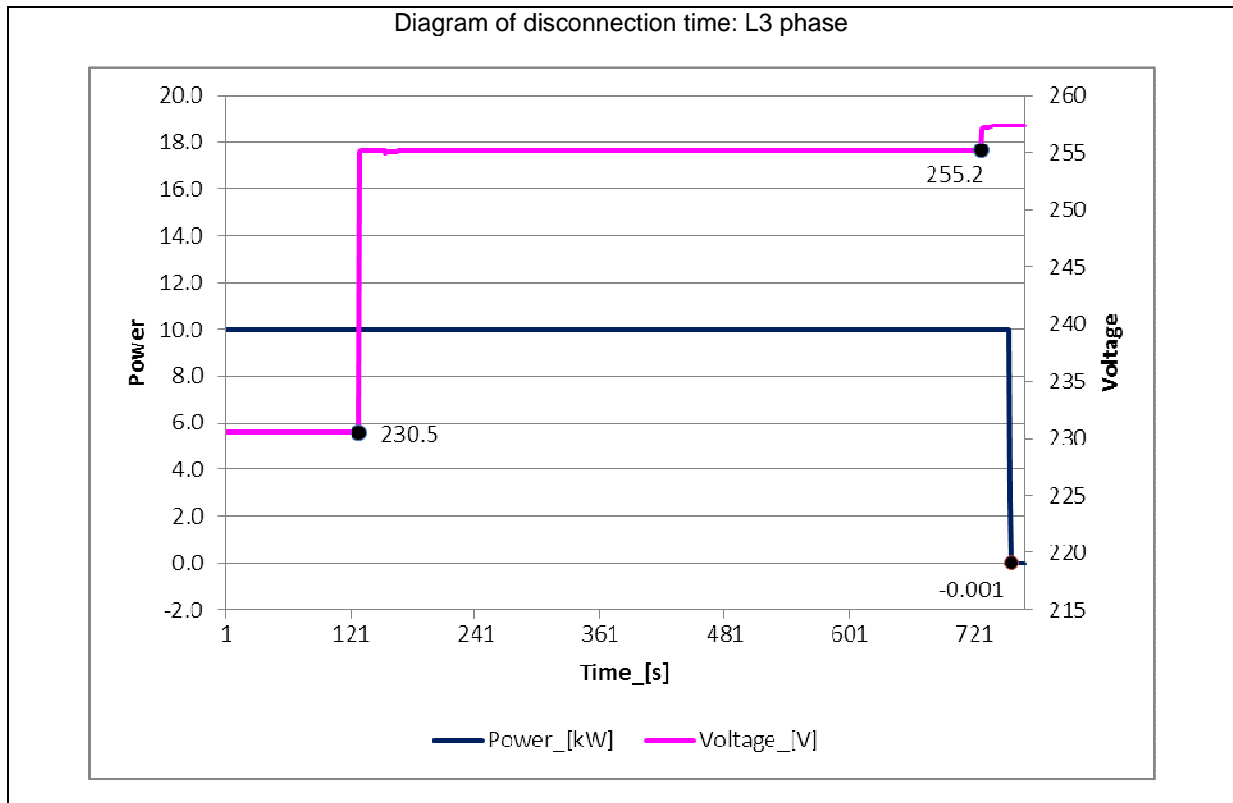

7.5.2 Limits for sustained operation Appendix H2 Sustained operation for voltage variations New Zealand			P	
Output power level: 50+/-5% Apparent Power				
Setting values	Setting V _{nom_max} [V]	248,0		
	Setting T _{disconnection} [s]	25,0		
Test:				
Step 1. The voltage is set to V _{nom_max} – 1 V. Maintained for 5 min. Step 2. The voltage increase to V _{nom_max} + 1 V and proceeding 10 min. Step 3. The 10 min average voltage shall be recorded.				
a)	Average Voltage (V)		Limit	
	Phase 1	1 st time	248,0	1. Disconnection should take place. 2. Voltage within +/1 % of the set-point.
		2 nd time	248,0	
		3 rd time	248,0	
	Phase 2	1 st time	249,0	
		2 nd time	248,9	
		3 rd time	249,0	
	Phase 3	1 st time	248,5	
		2 nd time	248,4	
3 rd time		248,5		
Step 1. The voltage is set to V _{nom_max} and maintained for 10 min. Step 2. Increase 2 V to trig the protection. Step 3. Record the disconnection time.				
b)	Disconnection time (s)		Limit	
	Phase 1	18	Disconnection time < 30s	
	Phase 2	19		
	Phase 3	23		
Step 1. The output voltage of variable a.c. supply decrease the voltage to grid test voltage. Step 2. Record the reconnection time.				
c)	Reconnection time (s)		Limit	
	Phase 1	86	Reconnection time > 60s	
	Phase 2	75		
	Phase 3	92		
Note: 1. The default set-point for V _{nom-max} shall be as follows: (a) In Australia: 255 V. (b) In New Zealand: 248 V. 2. The 10 min average value shall be compared against the limit V _{nom_max} at least every 3 s to determine when to disconnect. 3. The inverter shall operate the automatic disconnection device (see Clause 7.2) within 3 s when the average voltage for a 10 min period exceeds the V _{nom_max} . The tests had been performed on the SOFAR 20000TL-Sx Series is valid for the SOFAR 10000TL-Sx Series, SOFAR 15000TL-Sx Series and SOFAR 17000TL-Sx Series, since it is similar in hardware and just power derated by software.				

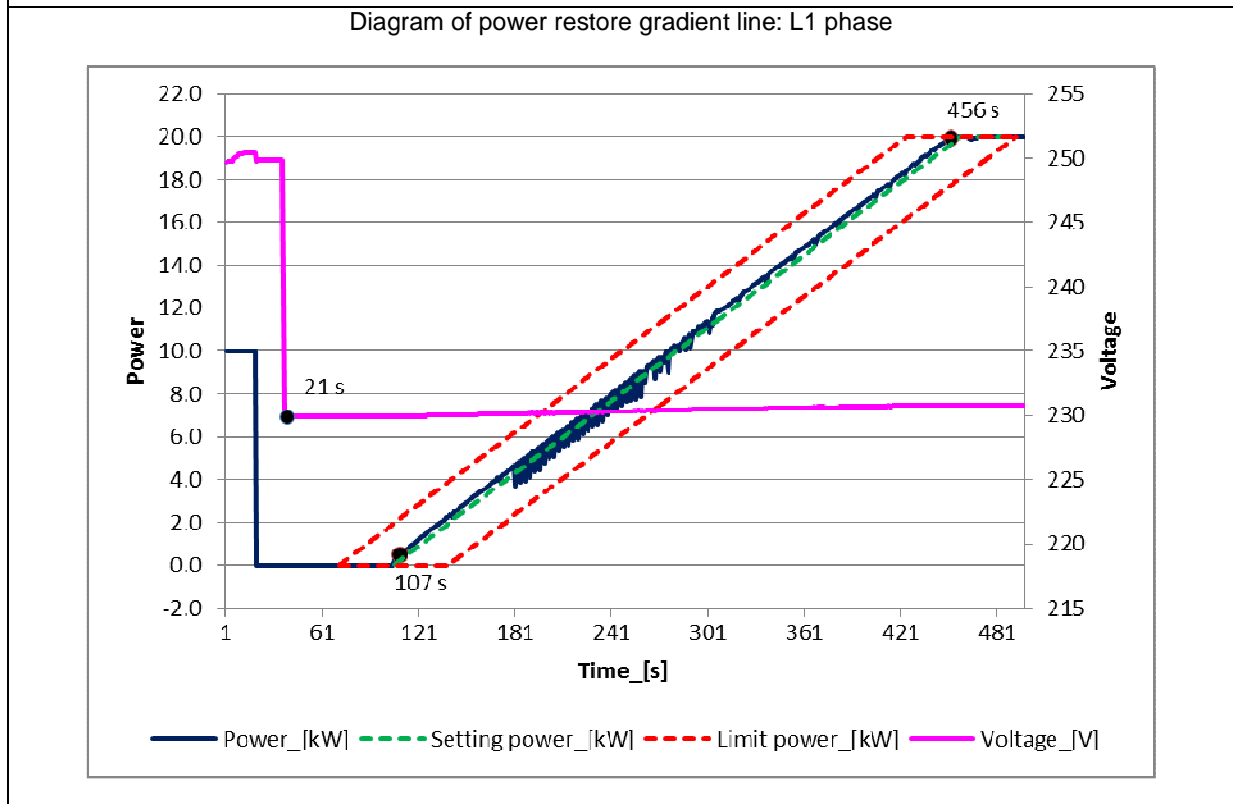
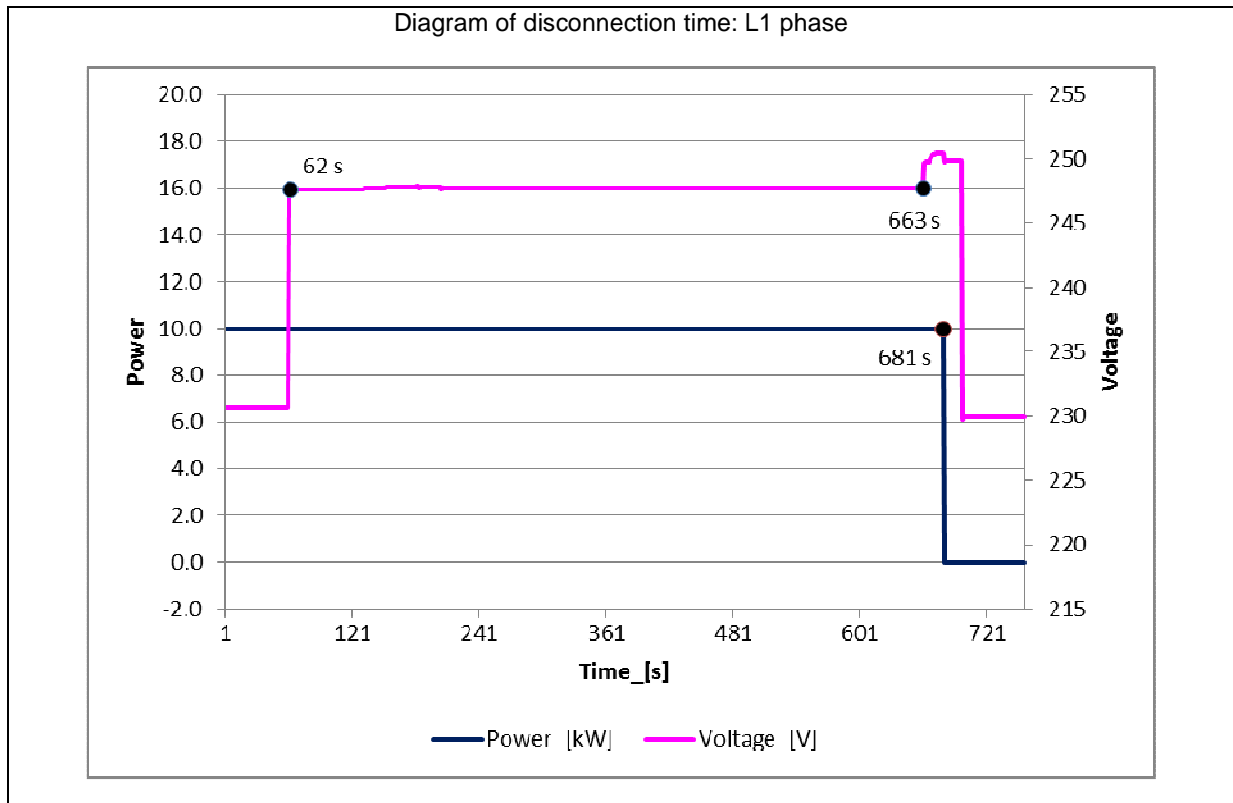

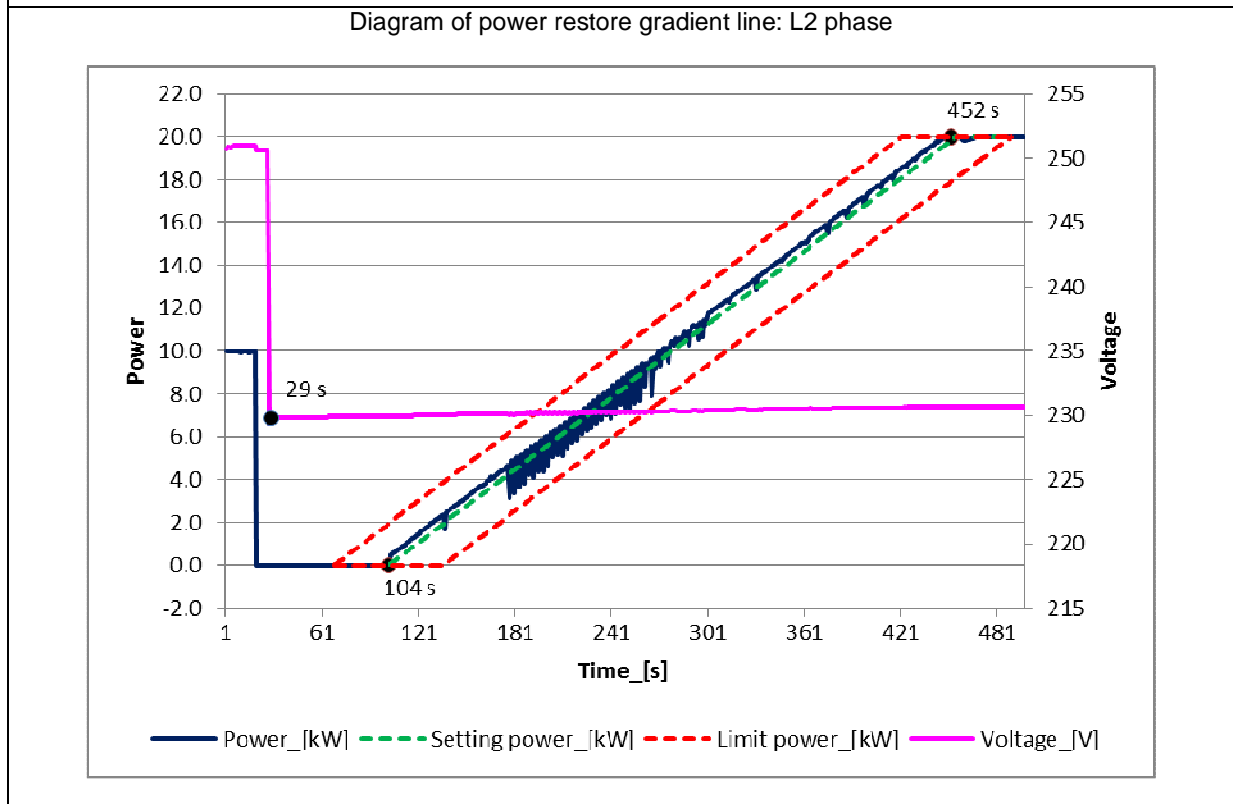
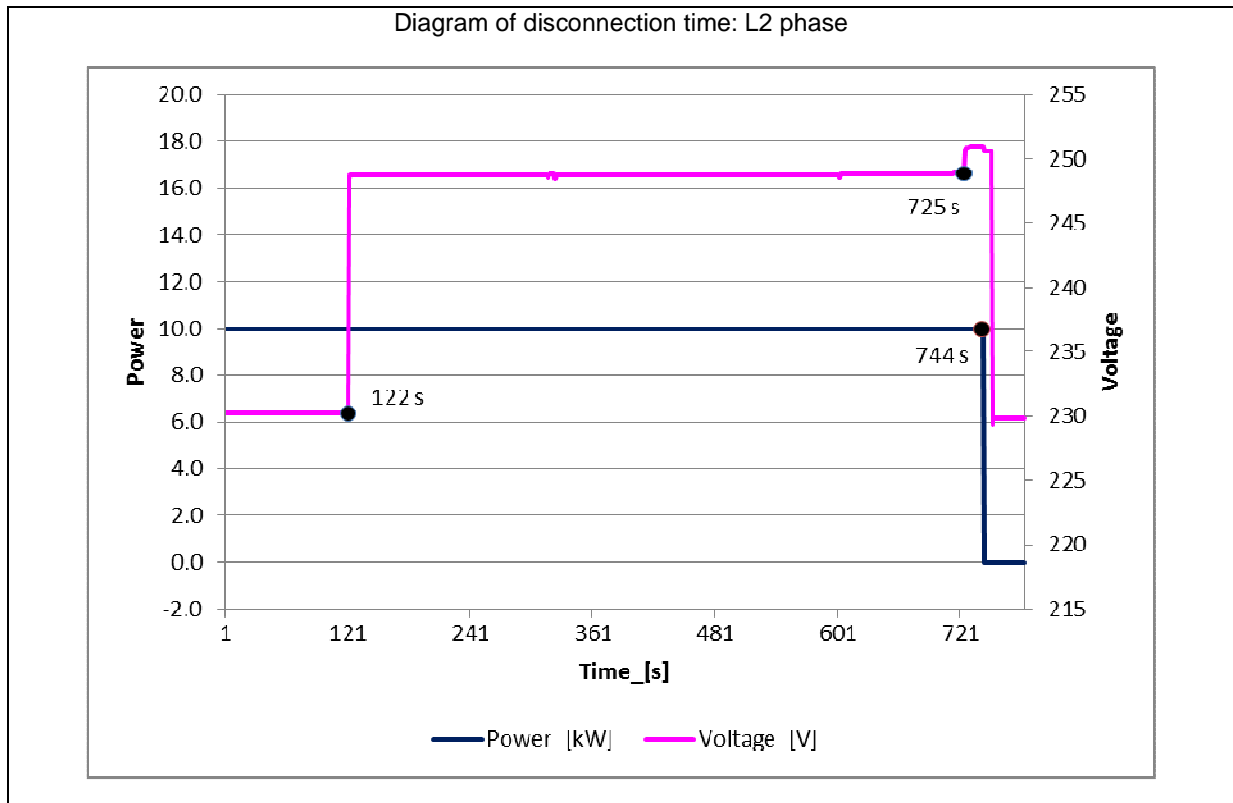

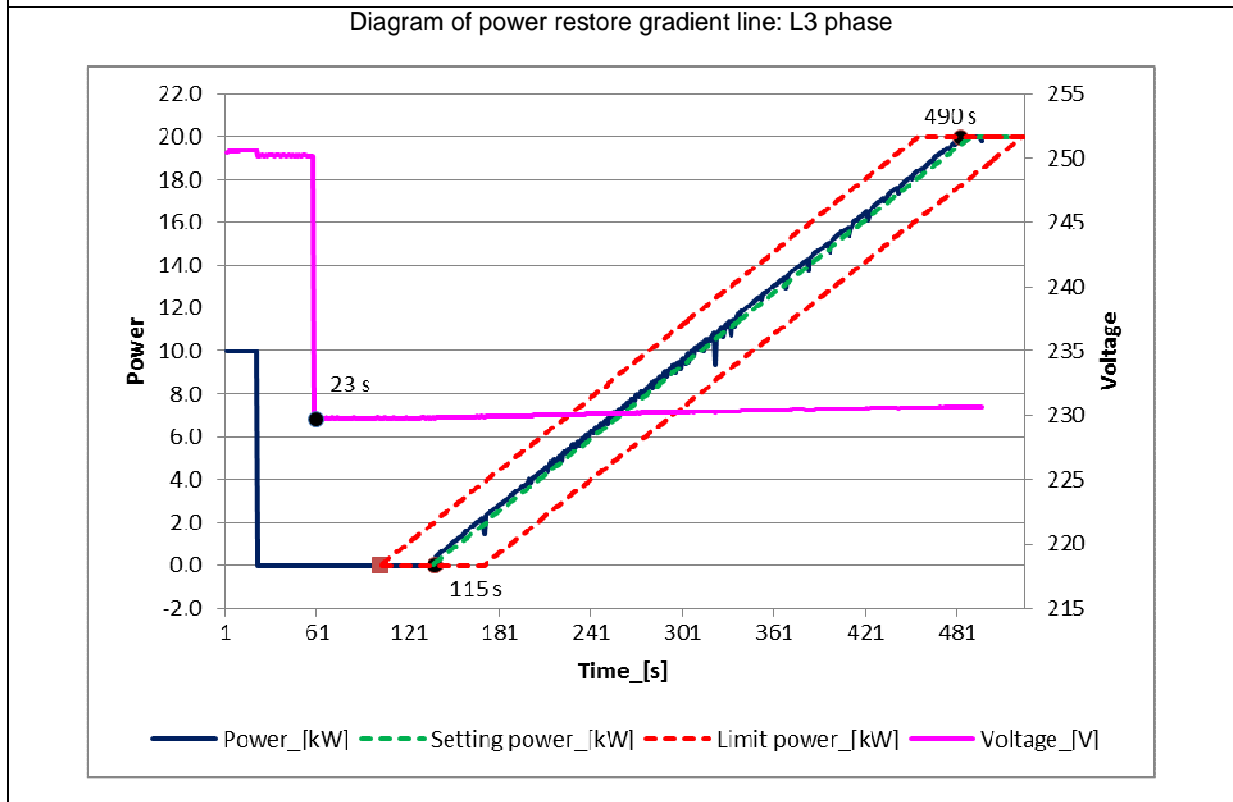
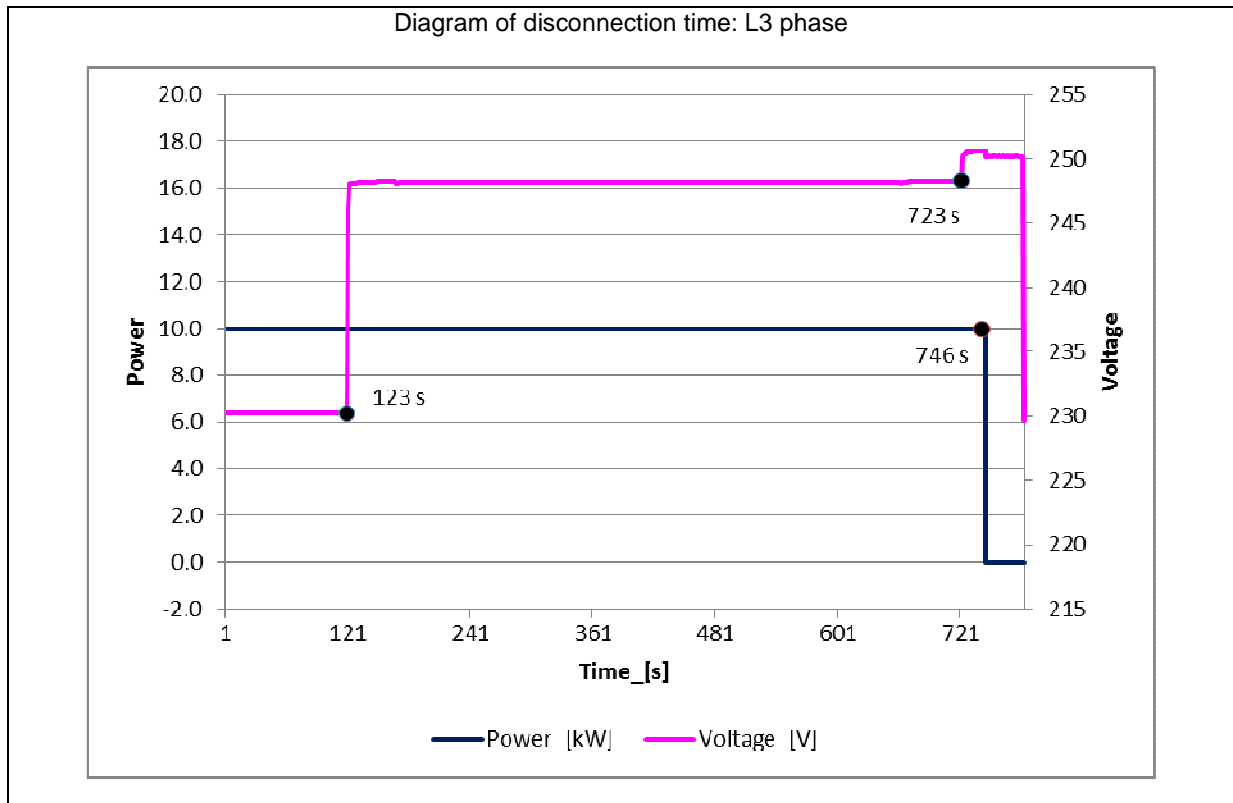

7.5.3.1 Response to an increase in frequency Appendix H3.2 Test procedure							P
1. Measurement a) to w): Power output: 50+/-5% of rated apparent power							
30s mean value	a) 50,00Hz	b) 50,25Hz	c) 50,35Hz	d) 50,45Hz	e) 50,55Hz	f) 50,65Hz	g) 50,75Hz
Frequency [Hz]:	50,00	50,25	50,35	50,45	50,55	50,65	50,75
P _{setpoint} [kW]:	10,000	10,000	9,400	8,831	8,261	7,691	7,121
P [kW]:	9,970	9,970	9,400	8,820	8,230	7,660	7,090
$\Delta P/P_{Setpoint}$ [%]:	-0,3	-0,3	0,0	-0,1	-0,3	-0,3	-0,3
30s mean value	h) 50,85Hz	i) 50,95Hz	j) 51,05Hz	k) 51,15Hz	l) 51,25Hz	m) 51,35Hz	n) 51,45Hz
Frequency [Hz]:	50,85	50,95	51,05	51,15	51,25	51,35	51,45
P _{setpoint} [kW]:	6,552	5,982	5,412	4,843	4,273	3,703	3,133
P [kW]:	6,520	5,960	5,370	4,810	4,240	3,690	3,110
$\Delta P/P_{Setpoint}$ [%]:	-0,3	-0,2	-0,4	-0,3	-0,3	-0,1	-0,2
30s mean value	o) 51,55Hz	p) 51,65Hz	q) 51,75Hz	r) 51,85Hz	s) 51,95Hz	t) 52,05Hz	u) 52,15Hz
Frequency [Hz]:	51,55	51,65	51,75	51,85	51,95	52,05	52,15
P _{setpoint} [kW]:	2,564	1,994	1,424	0,855	0,285	0,000	0,000
P [kW]:	2,530	1,960	1,360	0,770	0,200	0,020	0,020
$\Delta P/P_{Setpoint}$ [%]:	-0,3	-0,3	-0,6	-0,8	-0,8	0,2	0,2
<p><i>The frequency shall be decreased every 30 s in 0,2 Hz decrements from 52,25Hz until less than 50,15Hz. Maintained for 10 min or until the inverter reaches the maximum output power available. After frequency decreased to less than 50,15Hz, adjust output power to 100% rated power.</i></p>							
30s mean value	v) 52,25Hz	->	w) 50,05Hz	N/A	N/A	N/A	N/A
Frequency [Hz]:	52,25	N/A	50,05	N/A	N/A	N/A	N/A
P _{setpoint} [kW]:	0,000	N/A	0,000	N/A	N/A	N/A	N/A
P [kW]:	0,020	N/A	0,020	N/A	N/A	N/A	N/A
$\Delta P/P_{Setpoint}$ [%]:	0,2	N/A	0,2	N/A	N/A	N/A	N/A
Limit W _{Gra} :	+ 17 %						
Note:							
<p>1. The output power at grid test voltage/50,00Hz shall be maintained for 5 min and the average power shall be used as the frozen value of power (Pref)</p> <p>2. The frequency increase rate: 0.1Hz/step/30s.</p> <p>3. The frequency decrease rate: 0.2Hz/step/30s.</p> <p>4. While the frequency decrease less than 50,15Hz, the voltage and frequency shall be maintained for 10 min or until the inverter reaches the maximum output power available.</p> <p>5 After frequency decrease less than 50,15Hz, adjust output power to 100% rated power.</p>							
<p>The tests had been performed on the SOFAR 20000TL-Sx Series is valid for the SOFAR 10000TL-Sx Series, SOFAR 15000TL-Sx Series and SOFAR 17000TL-Sx Series, since it is similar in hardware and just power derated by software.</p>							

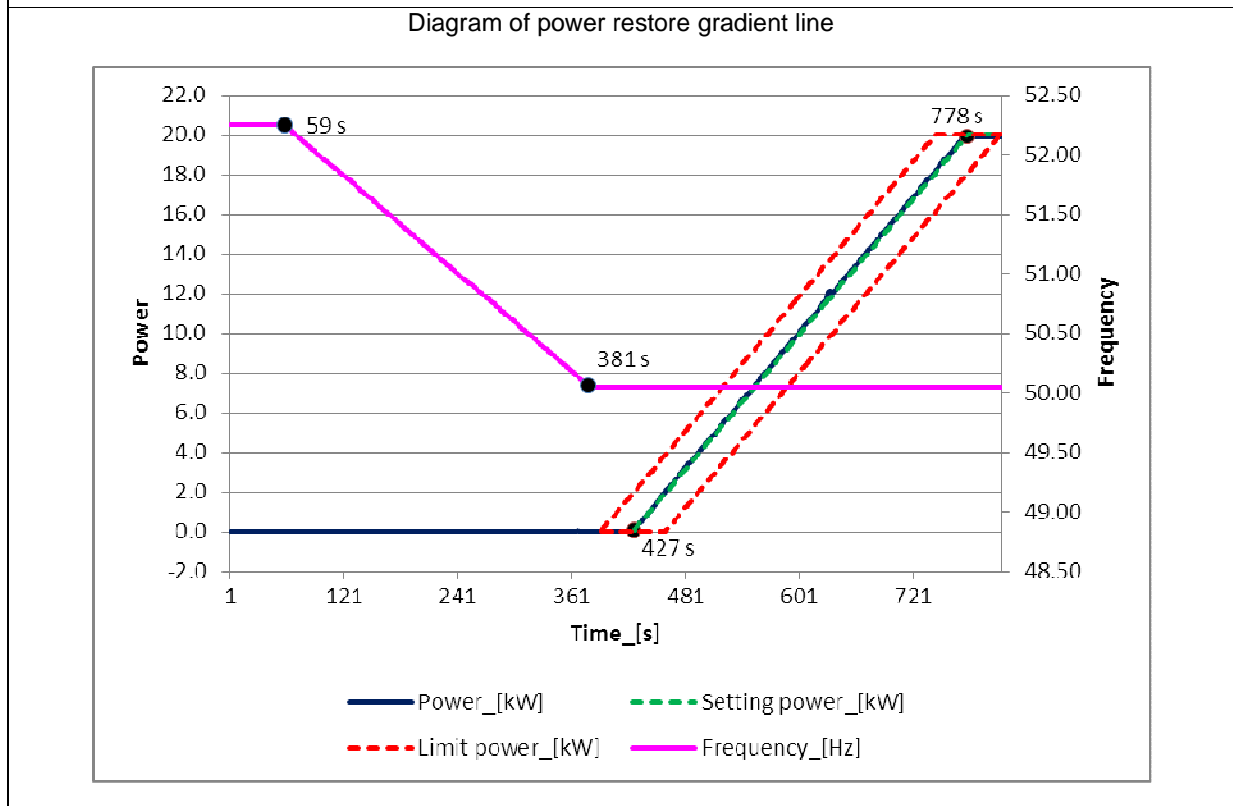
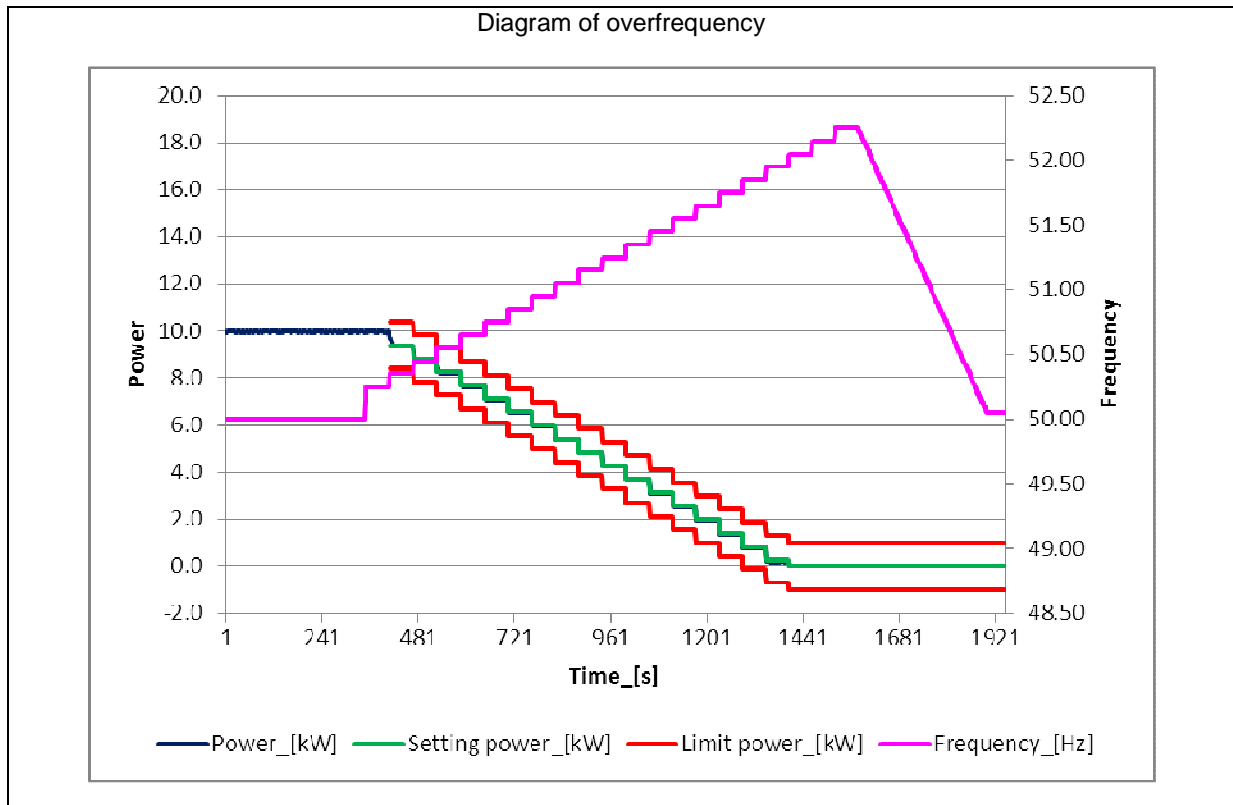

7.5.3.1 Response to an increase in frequency (continued) Appendix H3.2 Test procedure (continued)							P
2. Measurement a) to o): Power output: 50+/-5% of rated apparent power							
30s mean value	a) 50,00Hz	b) 50,25Hz	c) 50,35Hz	d) 50,45Hz	e) 50,55Hz	f) 50,65Hz	g) 50,75Hz
Frequency [Hz]:	50,00	50,25	50,35	50,45	50,55	50,65	50,75
P _{setpoint} [kW]:	10,000	10,000	9,381	8,813	8,244	7,676	7,107
P [kW]:	9,960	9,950	9,390	8,800	8,220	7,660	7,090
$\Delta P/P_{Setpoint}$ [%]:	-0,20	-0,25	0,04	-0,06	-0,12	-0,08	-0,09
30s mean value	h) 50,85Hz	i) 50,95Hz	j) 51,05Hz	N/A	N/A	N/A	N/A
Frequency [Hz]:	50,85	50,95	51,05	N/A	N/A	N/A	N/A
P _{setpoint} [kW]:	6,539	5,970	5,401	N/A	N/A	N/A	N/A
P [kW]:	6,520	5,970	5,370	N/A	N/A	N/A	N/A
$\Delta P/P_{Setpoint}$ [%]:	-0,09	0,00	-0,16	N/A	N/A	N/A	N/A
<p><i>The frequency shall be decreased every 30 s in 0,2 Hz decrements from 51,05Hz until less than 50,15Hz. Maintained for 10 min or until the inverter reaches the maximum output power available. After frequency decreased to less than 50,15Hz, adjust output power to 100% rated power.</i></p>							
30s mean value	k) 50,85Hz	l) 50,65Hz	m) 50,45Hz	n) 50,25Hz	o) 50,05Hz	N/A	N/A
Frequency [Hz]:	50,85	50,65	50,45	50,25	50,05	N/A	N/A
P _{setpoint} [kW]:	5,401	5,401	5,401	5,401	5,401	N/A	N/A
P [kW]:	5,370	5,370	5,370	5,360	5,350	N/A	N/A
$\Delta P/P_{Setpoint}$ [%]:	-0,16	-0,16	-0,16	-0,21	-0,26	N/A	N/A
Limit W_{GrA}:	+ 17 %						
<p>Note:</p> <ol style="list-style-type: none"> 1. The output power at grid test voltage/50,00Hz shall be maintained for 5 min and the average power shall be used as the frozen value of power (Pref) 2. The frequency increase rate: 0.1Hz/step/30s. 3. The frequency decrease rate: 0.2Hz/step/30s. 4. While the frequency decrease less than 50,15Hz, the voltage and frequency shall be maintained for 10 min or until the inverter reaches the maximum output power available. 5. After frequency decrease less than 50,15Hz, adjust output power to 100% rated power. <p>The tests had been performed on the SOFAR 20000TL-Sx Series is valid for the SOFAR 10000TL-Sx Series, SOFAR 15000TL-Sx Series and SOFAR 17000TL-Sx Series, since it is similar in hardware and just power derated by software.</p>							

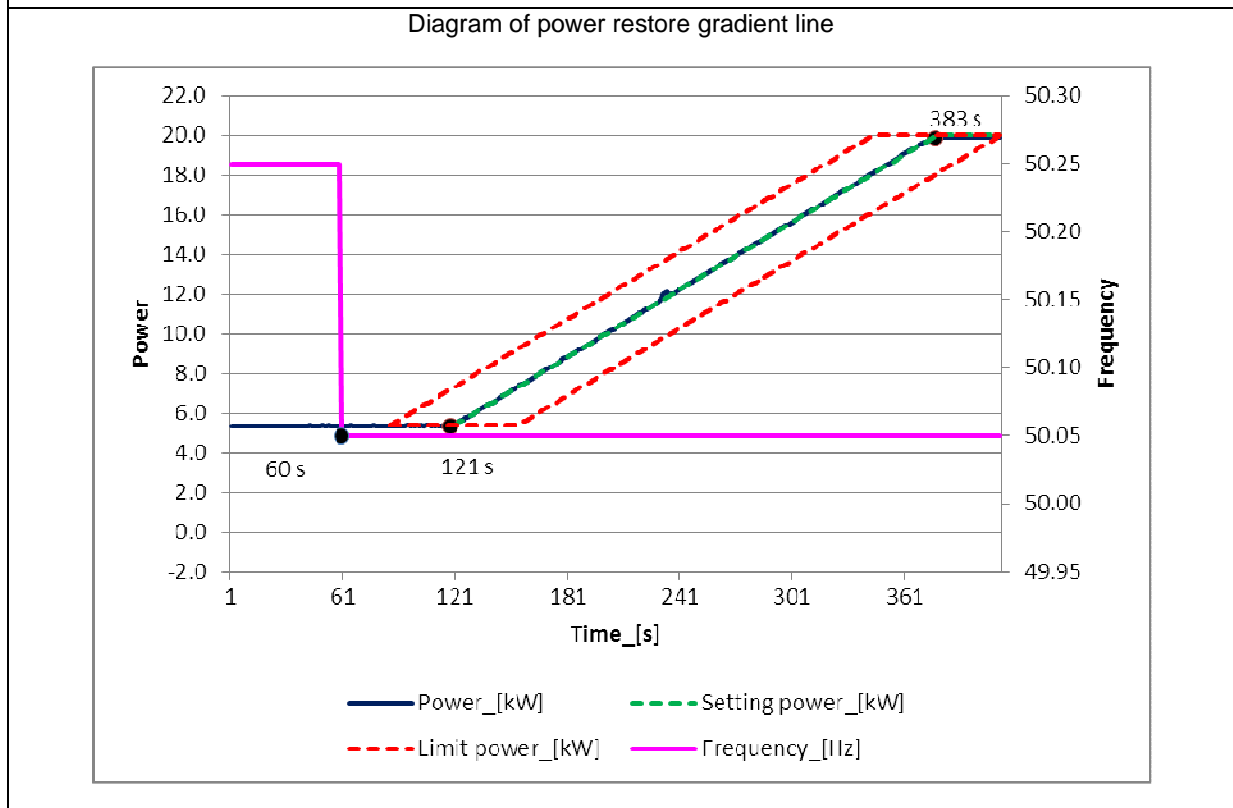
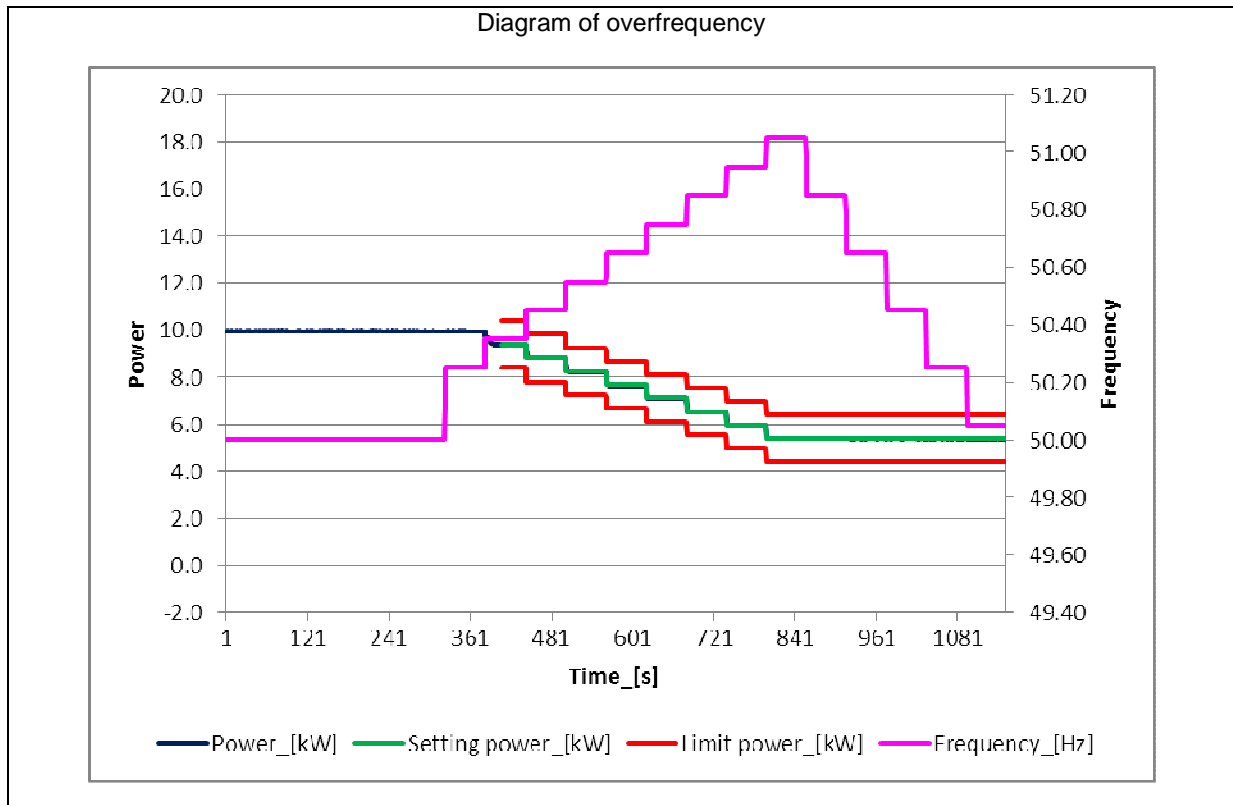



Annex 1

EMC Test Report



STC (Dongguan) Company Limited
CERTIFICATE OF COMPLIANCE

Reference Number: EMC-D163085COC

APPLICANT:

Shenzhen SOFARSOLAR Co., Ltd.
3A-1, Huake Building, East Technology Park, Qiaoxiang Road, Nanshan District, Shenzhen, China.

DESCRIPTION OF SAMPLE:

Product: PV Inverter
Manufacturer: Shenzhen SOFARSOLAR Co., Ltd.
3A-1, Huake Building, East Technology Park, Qiaoxiang Road,
Nanshan District, Shenzhen, China.
Model No.: Sofar 20000TL-Sx Series
Additional Model No.: Sofar 10000TL-Sx Series, Sofar 15000TL-Sx Series,
Sofar 17000TL-Sx Series
Brand Name: SOFAR
Origin: China

Applicable Standard(s) with amendments:

EN61000-6-3: 2007 +A1: 2011, EN61000-6-2: 2005
EN61000-3-2: 2014, EN61000-3-3: 2013
EN61000-3-11: 2001, EN61000-3-12: 2011

REFERENCE TEST REPORT NUMBER: DM122443.

This Certificate shall be used in conjunction with the above mentioned test report.

This is to certify that the submitted sample has been tested in accordance with and found to be in compliance with the said investigation.

Date: 2016-04-01



LONG Yin Jian, AIGG
Authorized Signatory
ElectroMagnetic Compatibility Department
For and on behalf of
STC (Dongguan) Company Limited

www.dgstc.org



STC Test Report



Date: 2016-04-01
No.: DM122443

Page 1 of 60

Applicant: Shenzhen SOFAR.SOLAR Co., Ltd.
3A-1, Huake Building, East Technology Park, Qiaoxiang
Road, Nanshan District, Shenzhen, China.

Description of Sample(s): Submitted sample(s) said to be
Product: PV Inverter
Brand Name: SOFAR
Model Number: Sofar 20000TL-Sx Series
Additional Model: Sofar 10000TL-Sx Series,
Number(s): Sofar 15000TL-Sx Series,
Sofar 17000TL-Sx Series

Date Sample(s) Received: 2015-11-27

Date Tested: 2015-12-01 to 2016-03-22

Investigation Requested: Test for compliance with EMC requirements of
EN61000-6-3, EN61000-6-2, EN61000-3-2, EN61000-3-3,
EN61000-3-11 and EN61000-3-12.

Conclusion(s): The submitted product **COMPLIED** with the requirements
of EN61000-6-3: 2007 +A1: 2011, EN61000-6-2: 2005,
EN61000-3-2: 2014, EN61000-3-3: 2013, EN61000-3-11:
2001 and EN61000-3-12: 2011. The EMC tests were
performed in accordance with the standards described above
and on Section 2.2 in this Test Report.

Remark(s): Deutsche Akkreditierungsstelle GmbH (DAkkS) has
accredited this laboratory for specific laboratory activities as
listed in the directory of accredited laboratories
(D-PL-12121-01-00)



LONG Yun
Authorized Signature
ElectroMagnetic Compatibility Department
For and on behalf of
STC (Dongguan) Company Limited

STC (Dongguan) Company Limited

88 Famin Nan Road, Daling, Dongguan, China. (Zip Code: 523 770)
Tel: (86 769) 8111 9888 Fax: (86 769) 8111 0222 E-mail: dgstc@dgstc.org Homepage: www.dgstc.org
This report shall not be reproduced unless with prior written approval from STC (Dongguan) Company Limited.
For Conditions of Issuance of this test report, please refer to the coverleaf or Homepage.



STC Test Report

Date: 2016-04-01
No.: DMI22443

Page 2 of 60

CONTENT:
Cover
Content

Page 1 of 60
Page 2 of 60

1.0 General Details

- 1.1 Equipment Under Test [EUT]
Description of Sample(s)
- 1.2 Date of Order
- 1.3 Submitted Sample(s)
- 1.4 Test Duration
- 1.5 Country of Origin

Page 4 of 60
Page 4 of 60
Page 4 of 60
Page 4 of 60
Page 4 of 60

2.0 Technical Details

- 2.1 Investigations Requested
- 2.2 Test Standards and Results Summary

Page 5 of 60
Page 5-6 of 60

3.0 Test Results

- 3.1 Emission
- 3.2 Immunity

Page 7-41 of 60
Page 42-60 of 60

Appendix A

List of Measurement Equipment

Page A1-A3 of A3

Appendix B

Photograph(s) of Product

Page B1-B10 of B10

STC (Dongguan) Company Limited

88 Fumin Nan Road, Dongguan, China. (Zip Code: 523 770)
Tel: (86 769) 8111 8666. Fax: (86 769) 8111 8222. E-mail: dgstc@dgstc.org Homepage: www.dgstc.org
This report shall not be reproduced unless with prior written approval from STC (Dongguan) Company Limited.
For Conditions of Issuance of this test report, please refer to the overleaf or Homepage.



STC Test Report

Date: 2016-04-01
No.: DMI22443

Page 3 of 60

1.0 General Details

1.1 Equipment Under Test (EUT) Description of Sample(s)

Product: PV Inverter
 Manufacturer: Shenzhen SOFARSOLAR Co., Ltd.
 3A-1, Huake Building, East Technology Park, Qiaoxiang Road,
 Nanshan District, Shenzhen, China.
 Brand Name: SOFAR
 Model Number: Sofar 20000TL-Sx Series
 Additional Model Number(s): Sofar 10000TL-Sx Series, Sofar 15000TL-Sx Series,
 Sofar 17000TL-Sx Series.

Rating:

Model	Sofar 10000TL-Sx Series	Sofar 15000TL-Sx Series	Sofar 17000TL-Sx Series	Sofar 20000TL- Sx Series
Output data (Grid)				
Maximum AC output	10000VA	15000VA	17000VA	20000VA
Maximum AC output current	15A	22A	25A	29A
Nominal AC voltage	230V	230V	230V	230V
Grid AC frequency	50Hz	50Hz	50Hz	50Hz
Power factor	0.999	0.999	0.999	0.999
Reactive power factor	-0.8~0.8	-0.8~0.8	-0.8~0.8	-0.8~0.8
Total harmonic distortion	<3%	<3%	<3%	<3%
AC connection/grid forms	3/N/PE, 230/400	3/N/PE, 230/400	3/N/PE, 230/400	3/N/PE, 230/400
Input data (solar)				
Maximum DC power	10500	15700	17700	21000
Maximum DC input current	15A*2	21A*2	21A*2	24A*2
Max number of MPP trackers	2	2	2	2
Maximum DC voltage	1000V	1000V	1000V	1000V
Operating voltage range	250V~960V	250V~960V	250V~960V	250V~960V
MPP tracking voltage range	250V~960V	250V~960V	250V~960V	250V~960V
Peak power tracking voltage range	350V~850V	370V~850V	420V~850V	430V~850V

STC (Dongguan) Company Limited

68 Fanyin Nan Road, Daling, Dongguan, China. (Zip Code: 523 770)
 Tel: (86 769) 8111 8866 Fax: (86 769) 8111 8222 E-mail: dgstc@dgstc.org Homepage: www.dgstc.org
 This report shall not be reproduced unless with prior written approval from STC (Dongguan) Company Limited.
 For Conditions of issuance of this test report, please refer to the overleaf or Homepage.



STC Test Report

Date: 2016-04-01
No.: DMI22443

Page 4 of 60

1.2 Date of Order

2015-11-27

1.3 Submitted Sample(s):

1 Sample

1.4 Test Duration

2015-12-01 to 2016-03-22

1.5 Country of Origin

China

STC (Dongguan) Company Limited

88 Fumin Nan Road, Dalang, Dongguan, China. (Zip Code: 523 770)
Tel: (86 769) 8111 9066 Fax: (86 769) 8111 8222 E-mail: dgstc@dgstc.org Homepage: www.dgstc.org
This report shall not be reproduced unless with prior written approval from STC (Dongguan) Company Limited.
For Conditions of issuance of this test report, please refer to the overleaf or Homepage.



STC Test Report

Date: 2016-04-01
No.: DMI22443

Page 5 of 60

2.0 Technical Details

2.1 Investigations Requested

Perform ElectroMagnetic Interference [EMI] & ElectroMagnetic Susceptibility [EMS] tests for CE Marking

2.2 Test Standards and Results Summary Tables

Test Standards	
EN61000-6-3: 2007 +A1:2011	Electromagnetic compatibility (EMC) - Part 6-3: Generic standards - Emission standard for residential, commercial and light-industrial environments
EN61000-6-2: 2005	Electro-magnetic compatibility (EMC) - Part 6-2: Generic standards - Immunity for industrial environments
EN61000-3-2: 2014	Electromagnetic compatibility (EMC) - Part 3-2: Limits - Limits for harmonic current emissions (equipment input current ≤ 16 A per phase)
EN61000-3-3: 2013	Electromagnetic compatibility (EMC) - Part 3-3: Limits - Limitation of voltage changes, voltage fluctuations and flicker in public low-voltage supply systems, for equipment with rated current ≤ 16 A per phase and not subject to conditional connection
EN61000-3-11: 2001	Electromagnetic compatibility (EMC) - Part 3-11: Limits - Limitation of voltage changes, voltage fluctuations and flicker in public low-voltage supply systems - Equipment with rated current ≤ 75 A and subject to conditional connection
EN61000-3-12: 2011	Electromagnetic compatibility (EMC) - Part 3-12: Limits - Limits for harmonic currents produced by equipment connected to public low-voltage systems with input current >16 A and ≤ 75 A per phase

STC (Dongguan) Company Limited

69 Fanchi Nan Road, Daling, Dongguan, China. (Zip Code: 523770)
Tel: (86 769) 8111 9606 Fax: (86 769) 8111 6222 E-mail: dqstc@dgstc.org Homepage: www.dgstc.org
This report shall not be reproduced unless with prior written approval from STC (Dongguan) Company Limited.
For Conditions of Issuance of this test report, please refer to the coverleaf or Homepage.



STC Test Report

Date: 2016-04-01
No.: DMI22443

Page 6 of 60

2.2 Test Standards and Results Summary Tables

EMISSION (EN 61000-6-3:2007+A1:2011) Results Summary					
Test Condition	Test Requirement	Limits	Test Result		
			Pass	Failed	N/A
Radiated Emission, 30MHz to 1000MHz	EN61000-6-3: 2007+ A1:2011	Table 1	<input checked="" type="checkbox"/>	<input type="checkbox"/>	<input type="checkbox"/>
Conducted Emission on at main terminal 150kHz to 30MHz	EN61000-6-3: 2007+ A1:2011	Table 1	<input checked="" type="checkbox"/>	<input type="checkbox"/>	<input type="checkbox"/>
Harmonic current emissions	EN61000-3-2: 2014	Class A	<input checked="" type="checkbox"/>	<input type="checkbox"/>	<input type="checkbox"/>
	EN 61000-3-12: 2011				
Voltage fluctuations & Flicker	EN61000-3-3: 2013	Pst-l dc(%)=3.3% dMax(%)=4% d(t)=-3.3%=500ms	<input checked="" type="checkbox"/>	<input type="checkbox"/>	<input type="checkbox"/>
	EN 61000-3-11: 2001				

IMMUNITY (EN 61000-6-2:2005) Results Summary					
Test Condition	Test Requirement	Performance Criteria	Test Result		
			Pass	Failed	N/A
Electrostatic Discharge	IEC 61000-4-2:2008	B	<input checked="" type="checkbox"/>	<input type="checkbox"/>	<input type="checkbox"/>
Radiated Immunity 80MHz to 2700MHz	IEC 61000-4-3:2008	A	<input checked="" type="checkbox"/>	<input type="checkbox"/>	<input type="checkbox"/>
Electrical Fast Transients	IEC 61000-4-4:2004 +Corr.1:2006+Corr.2:2007	B	<input checked="" type="checkbox"/>	<input type="checkbox"/>	<input type="checkbox"/>
Surge Immunity	IEC 61000-4-5:2005	B	<input checked="" type="checkbox"/>	<input type="checkbox"/>	<input type="checkbox"/>
Continuous RF Immunity	IEC 61000-4-6:2008	A	<input checked="" type="checkbox"/>	<input type="checkbox"/>	<input type="checkbox"/>
Power Frequency magnetic field	IEC 61000-4-8:2009	A	<input checked="" type="checkbox"/>	<input type="checkbox"/>	<input type="checkbox"/>
Common Mode Disturbance	IEC 61000-4-16:1998+A1:2001 +A2:2009	A	<input checked="" type="checkbox"/>	<input type="checkbox"/>	<input type="checkbox"/>
Oscillatory Waves	IEC 61000-4-18:2011	B	<input checked="" type="checkbox"/>	<input type="checkbox"/>	<input type="checkbox"/>
DC Voltage Dips and Interruptions	IEC 61000-4-29:2000	B	<input checked="" type="checkbox"/>	<input type="checkbox"/>	<input type="checkbox"/>

Note: The performance criteria for immunity test is referring to the standard of CEI 0-21:2012.
The scope of DAkkS accreditation not indicates the standard of
IEC 61000-4-16:1998+A1:2001+A2:2009, IEC 61000-4-18:2011, IEC 61000-4-29:2000.

Remarks:
N/A: Not Applicable
U_n: The nominal supply voltage

STC (Dongguan) Company Limited

88 Fubin Nan Road, Daling, Dongguan, China. (Zip Code: 523 770)
Tel: (86 769) 8111 9056 Fax: (86 769) 8111 8222 E-mail: dgstc@dgstc.org Homepage: www.dgstc.org
This report shall not be reproduced unless with prior written approval from STC (Dongguan) Company Limited.
For Conditions of issuance of this test report, please refer to the coverleaf or Homepage.



STC Test Report

Date: 2016-04-01
No.: DM122443

Page 7 of 60

3.0 Test Results

3.1 Emission

3.1.1 Radiated Emissions (30MHz to 1000MHz)

Test Requirement: EN 61000-6-3
Test Method: EN 55022
Level: Table 1

Mode of Operation: Full load and Grid mode

Test Method:

The test was performed in accordance with EN 55022 at 10m test distance on a standard emission test site, with quasi-peak measurements performed if the maximised peak measurements were less than 6dB from the corresponding Class B limit lines.

Test Procedure:

The EUT is a PV Inverter, the test was conducted during the full load and grid test function to simulate the normal usage as well as to produce the maximum electromagnetic disturbances.

Test Setup:

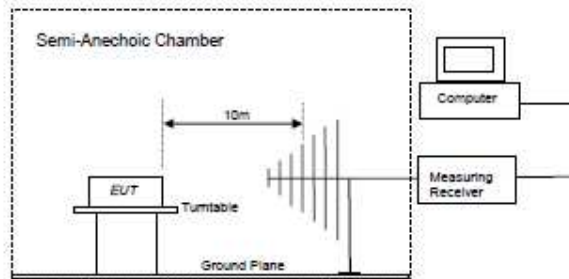

STC (Dongguan) Company Limited

65 Fanchi Nan Road, Daling, Dongguan, China. (Zip Code: 523770)
Tel: (86 769) 8111 9888 Fax: (86 769) 8111 6222 E-mail: dgstc@dgstc.org Homepage: www.dgstc.org
This report shall not be reproduced unless with prior written approval from STC (Dongguan) Company Limited.
For Conditions of issuance of this test report, please refer to the coverleaf or Homepage.



STC Test Report

Date: 2016-04-01
No.: DMI22443

Page 8 of 60

Limits for Radiated Emission:

Frequency Range [MHz]	Quasi-Peak Limits [dB μ V/m]
30-230	30.0
230-1000	37.0

Results of Full load and Grid mode(DC 650V): Pass
Please refer to the following table for result details

Horizontal

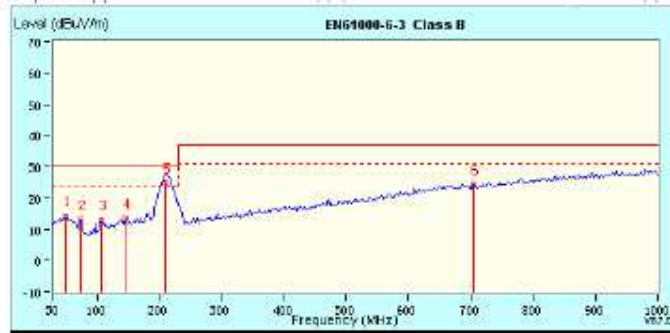

The quasi-peak measurements were recorded as follows:

No.	Frequency MHz	Factor dBm	Reading dBuV	Emission dBuV/m	Limit dBuV/m	Margin dB	Tower cm	Table deg
1	49.400	-14.11	28.11	14.00	30.00	-16.00	100	285
2	74.620	-17.46	30.38	12.92	30.00	-17.08	400	272
3	107.800	-17.60	30.33	12.73	30.00	-17.27	300	138
4	144.460	-14.47	27.76	13.28	30.00	-16.71	300	357
* 5	210.420	-16.00	40.71	24.71	30.00	-5.29	400	190
6	705.120	-3.13	27.51	24.38	37.00	-12.62	300	88

STC (Dongguan) Company Limited

88 Fulin Nan Road, Daling, Dongguan, China. (Zip Code: 523 770)
Tel: (86 769) 8111 9056 Fax: (86 769) 8111 8222 E-mail: dgstc@dgstc.org Homepage: www.dgstc.org
This report shall not be reproduced unless with prior written approval from STC (Dongguan) Company Limited.
For Conditions of issuance of this test report, please refer to the overleaf or Homepage.



STC Test Report

Date: 2016-04-01
No.: DMI22443

Page 9 of 60

Limits for Radiated Emission:

Frequency Range [MHz]	Quasi-Peak Limits [dB μ V/m]
30-230	30.0
230-1000	37.0

Results of Full load and Grid mode(DC 650V): Pass
Please refer to the following table for result details

Vertical

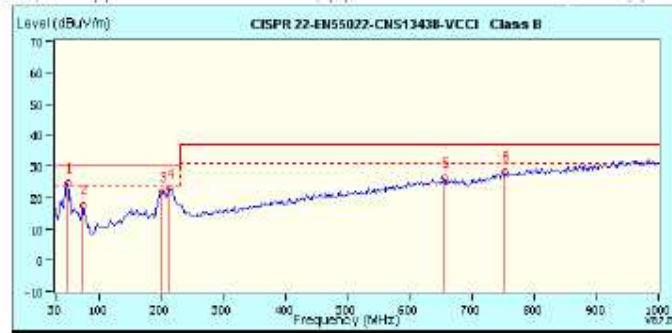

The quasi-peak measurements were recorded as follows:

No.	Frequency [MHz]	Factor [dBm]	Reading [dB μ V]	Emission [dB μ V/m]	Limit [dB μ V/m]	Margin [dB]	Tower [cm]	Table [dB μ V]
1	49.400	-14.13	39.69	24.56	30.00	-5.44	100	183
2	74.620	-17.36	34.97	17.61	30.00	-12.39	200	357
3	202.680	-15.41	37.29	21.88	30.00	-8.12	100	254
4	214.300	-14.62	37.86	23.04	30.00	-6.96	100	144
5	668.620	-1.43	27.66	26.23	37.00	-10.77	200	357
6	753.620	1.03	27.22	26.25	37.00	-6.75	100	181

STC (Dongguan) Company Limited

88 Fulin Nan Road, Daling, Dongguan, China. (Zip Code: 523770)
Tel: (86 769) 8111 9066 Fax: (86 769) 8111 8222 E-mail: dgstc@dgstc.org Homepage: www.dgstc.org
This report shall not be reproduced unless with prior written approval from STC (Dongguan) Company Limited.
For Conditions of issuance of this test report, please refer to the overleaf or Homepage.



STC Test Report

Date: 2016-04-01
No.: DM122443

Page 10 of 60

Limits for Radiated Emission:

Frequency Range [MHz]	Quasi-Peak Limits [dB μ V/m]
30-230	30.0
230-1000	37.0

Results of Full load and Grid mode(DC 450V): Pass
Please refer to the following table for result details

Horizontal

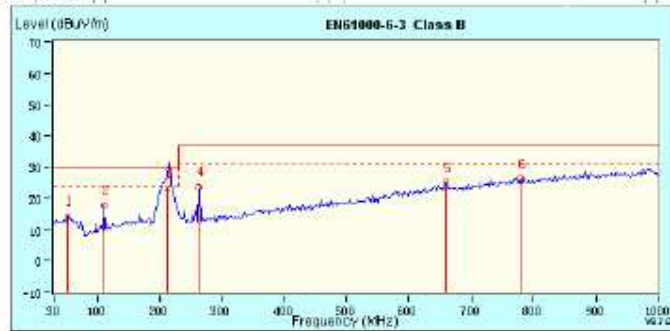

The quasi-peak measurements were recorded as follows:

No.	Frequency [kHz]	Factor [dBm]	Reading [dB μ V]	Emission [dB μ V/m]	Limit [dB μ V/m]	Margin [dB]	Tower [cm]	Table [deg]
1	53.280	-14.20	28.96	14.36	30.00	-15.64	200	297
2	111.480	-17.16	34.96	17.80	30.00	-12.20	300	158
3	211.960	-15.95	39.25	23.30	30.00	-6.70	200	125
4	292.800	-19.62	37.24	25.62	37.00	-11.38	200	10
5	660.500	-3.74	28.73	24.99	37.00	-12.01	200	128
6	779.840	-1.32	27.72	26.40	37.00	-10.60	100	356

STC (Dongguan) Company Limited

68 Fanyin Nan Road, Daling, Dongguan, China. (Zip Code: 523770)
Tel: (86 769) 8111 8866 Fax: (86 769) 8111 8222 E-mail: dgstc@dgstc.org Homepage: www.dgstc.org
This report shall not be reproduced unless with prior written approval from STC (Dongguan) Company Limited.
For Conditions of issuance of this test report, please refer to the overleaf or Homepage.



STC Test Report

Date: 2016-04-01
No.: DM122443

Page 11 of 60

Limits for Radiated Emission:

Frequency Range [MHz]	Quasi-Peak Limits [dB μ V/m]
30-230	30.0
230-1000	37.0

Results of Full load and Grid mode(DC 450V): Pass
Please refer to the following table for result details

Vertical

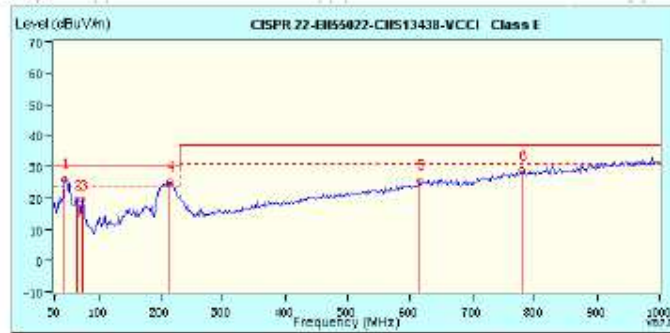

The quasi-peak measurements were recorded as follows:

No.	Frequency [MHz]	Factor [dB/m]	Reading [dB μ V]	Emission [dB μ V/m]	Limit [dB μ V/m]	Margin [dB]	Tower [cm]	Table [deg]
* 1	45.520	-13.59	39.83	26.04	30.00	-3.96	100	229
2	66.860	-15.78	35.32	19.54	30.00	-10.46	100	306
3	74.620	-17.36	36.76	19.40	30.00	-10.60	100	234
4	214.300	-14.82	40.10	25.28	30.00	-4.72	100	140
5	615.880	-2.11	27.85	25.74	37.00	-11.26	200	260
6	778.840	1.60	27.14	28.74	37.00	-8.26	200	129

STC (Dongguan) Company Limited

88 Fumin Nan Road, Daling, Dongguan, China. (Zip Code: 523 770)
Tel: (86 769) 8111 9066 Fax: (86 769) 8111 0222 E-mail: dgstc@gpctc.org Homepage: www.dgstc.org
This report shall not be reproduced unless with prior written approval from STC (Dongguan) Company Limited.
For Conditions of Issuance of this test report, please refer to the website or Homepage.



STC Test Report

Date: 2016-04-01
No.: DMI22443

Page 12 of 60

Limits for Radiated Emission:

Frequency Range [MHz]	Quasi-Peak Limits [dB μ V/m]
30-230	30.0
230-1000	37.0

Results of Full load and Grid mode(DC 850V): Pass
Please refer to the following table for result details

Horizontal

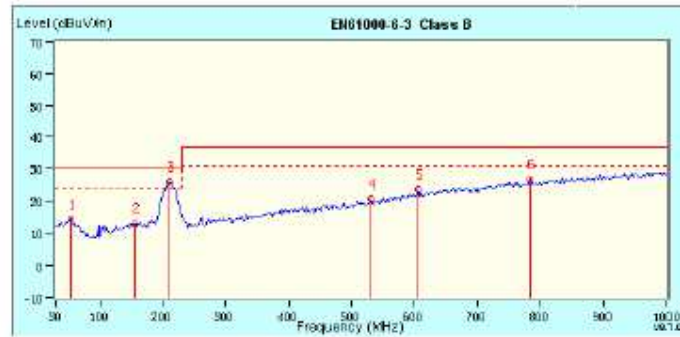

The quasi-peak measurements were recorded as follows:

No.	Frequency [MHz]	Factor [dB/m]	Reading [dB μ V]	Emission [dB μ V/m]	Limit [dB μ V/m]	Margin [dB]	Tower [m]	Table [deg]
1	55.220	-14.25	26.33	14.08	30.00	-15.92	100	314
2	156.100	-14.06	26.85	12.79	30.00	-17.21	300	300
3	210.420	-16.00	41.93	25.93	30.00	-4.07	400	347
4	530.520	-7.59	28.10	20.51	37.00	-16.49	100	224
5	804.240	-5.27	26.77	21.50	37.00	-13.50	200	277
6	782.720	-1.24	27.87	26.63	37.00	-10.37	100	24

STC (Dongguan) Company Limited

88 Fuzhi Nan Road, Daxing, Dongguan, China. (Zip Code: 523 770)
Tel: (86 769) 8111 9668 Fax: (86 769) 8111 0322 E-mail: dgstc@dgstc.org Homepage: www.dgstc.org
This report shall not be reproduced unless with prior written approval from STC (Dongguan) Company Limited.
For Conditions of issuance of this test report, please refer to the coverleaf or Homepage.



STC Test Report

Date: 2016-04-01
No.: DMI22443

Page 13 of 60

Limits for Radiated Emission:

Frequency Range [MHz]	Quasi-Peak Limits [dB μ V/m]
30-230	30.0
230-1000	37.0

Results of Full load and Grid mode(DC 850V): Pass
Please refer to the following table for result details

Vertical

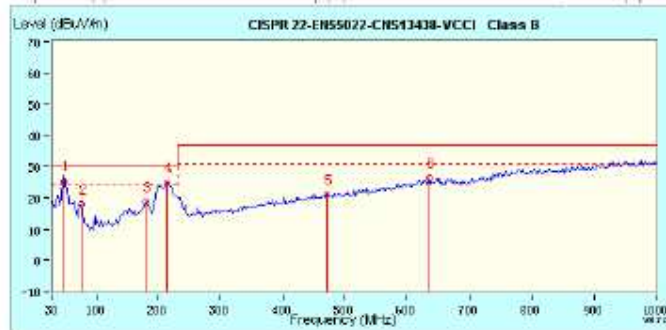

The quasi-peak measurements were recorded as follows:

No.	Frequency [MHz]	Factor [dBm]	Reading [dB μ V]	Emission [dB μ V/m]	Limit [dB μ V/m]	Margin [dB]	Lower [cm]	Table [deg]
1	67.600	-13.03	29.05	25.22	30.00	-4.78	100	90
2	76.580	-17.82	35.88	17.86	30.00	-12.14	100	116
3	179.380	-13.27	31.95	18.88	30.00	-11.32	100	209
4	214.300	-14.82	35.75	24.93	30.00	-5.07	100	149
5	472.320	-5.78	26.80	21.11	37.00	-15.89	400	340
6	635.280	-1.71	26.04	26.33	37.00	-10.67	300	293

Remarks:

Calculated measurement uncertainty (30MHz – 1GHz): 4.6dB
Emissions in the vertical and horizontal polarizations have been investigated and the worst-case test results are recorded in this report.

STC (Dongguan) Company Limited

88 Famin Han Road, Daxiang, Dongguan, China. (Zip Code: 523 770)
Tel: (86 769) 8111 9668 Fax: (86 769) 8111 0222 E-mail: dgstc@dgstc.org Homepage: www.dgstc.org
This report shall not be reproduced unless with prior written approval from STC (Dongguan) Company Limited.
For Conditions of Issuance of this test report, please refer to the coverleaf or Homepage.



STC Test Report

Date: 2016-04-01
No.: DMI22443

Page 14 of 60

3.1.2 Conducted Emission on at main terminal (150kHz to 30MHz)

Test Requirement: EN 61000-6-3
Test Method: EN 55022
Level: Table 1

Mode of Operation: Full load and Grid mode

Test Method:

Initial measurements were performed in peak and average detection modes on the live line. Any emissions recorded within 30dB of the relevant limit lines were re-measured using quasi-peak and average detection on the live and neutral lines with the worst case recorded in the table of results. The test was performed in accordance with EN 55022.

Test Procedure:

The EUT is a PV Inverter, the test was conducted during the full load and grid test function to simulate the normal usage as well as to produce the maximum electromagnetic disturbances.

Test Setup:

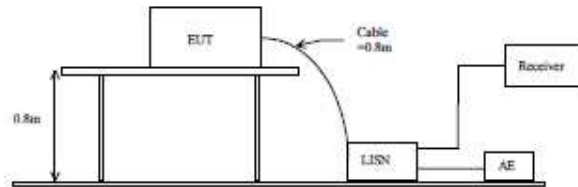

STC (Dongguan) Company Limited

88 Fumin Nan Road, Daling, Dongguan, China. (Zip Code: 523 770)
Tel: (86 769) 8111 8066 Fax: (86 769) 8111 8333 E-mail: dgstc@dgstc.org Homepage: www.dgstc.org
This report shall not be reproduced unless with prior written approval from STC (Dongguan) Company Limited.
For Conditions of Issuance of this test report, please refer to the overleaf or Homepage.



STC Test Report

Date: 2016-04-01
No.: DMI22443

Page 15 of 60

Results and limit lines for Conducted Emission:

Limits for Conducted Emission Test, please refer to limit lines (Quasi-Peak and Average) in the following diagram.

Results of Full load and Grid mode (DC 650V) (L1): Pass

Please refer to the following diagram for individual results.

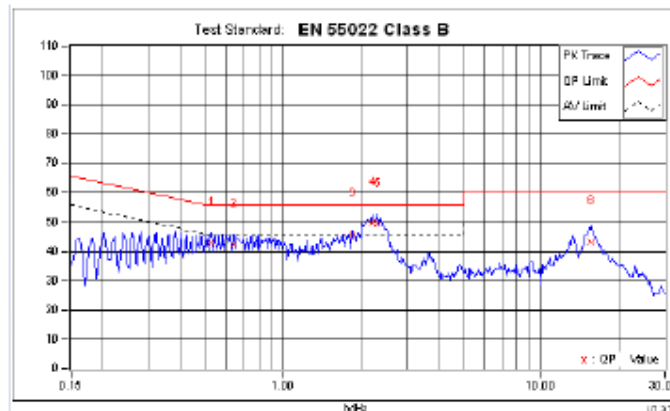

No.	Frequency kHz	Corr. Factor dB	Reading dBμV		Emission dBμV		Limit dBμV		Margin dB		Notes
			QP	AV	QP	AV	QP	AV	QP	AV	
1	0.52109	8.81	34.21	30.11	43.02	38.90	58.00	48.00	-12.98	-7.08	
2	0.59828	8.80	33.70	28.83	42.50	37.83	56.00	46.00	-13.41	-8.07	
3	1.83984	9.00	38.73	30.82	46.73	38.82	56.00	46.00	-10.27	-8.18	
H	2.19822	8.02	40.87	34.80	48.88	42.82	56.00	46.00	-6.11	-2.18	
5	3.30659	9.03	40.18	31.43	48.21	40.48	56.00	46.00	-8.79	-5.54	
6	15.45313	8.80	33.81	28.08	40.51	37.68	50.00	40.00	-16.48	-12.32	

STC (Dongguan) Company Limited

68 Famin Nan Road, Dalang, Dongguan, China. (Zip Code : 523 770)
Tel : (86 769) 8111 9668 Fax : (86 769) 8111 8322 E-mail : dgstc@dgstc.org Homepage : www.dgstc.org
This report shall not be reproduced unless with prior written approval from STC (Dongguan) Company Limited.
For Conditions of Issuance of this test report, please refer to the overleaf or Homepage.



STC Test Report

Date: 2016-04-01
No.: DMI22443

Page 16 of 60

Results and limit lines for Conducted Emission:
Limits for Conducted Emission Test, please refer to limit lines (Quasi-Peak and Average) in the following diagram.

Results of Full load and Grid mode (DC 650V) (L2): Pass
Please refer to the following diagram for individual results.

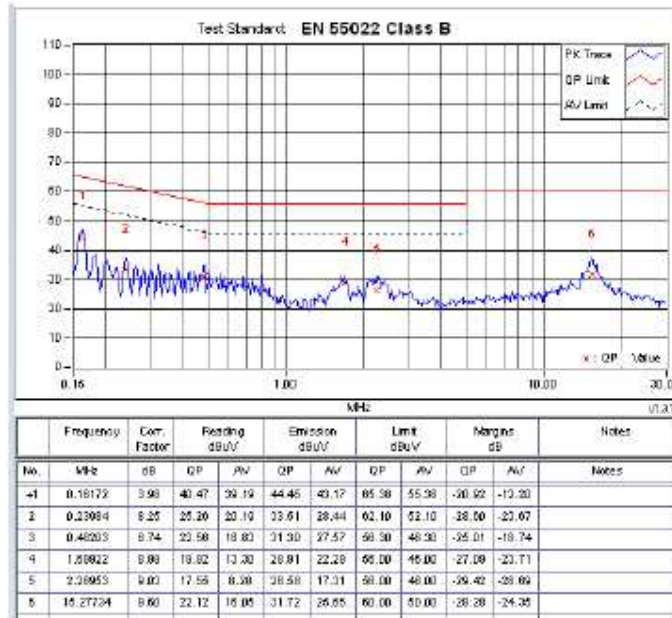

STC (Dongguan) Company Limited

88 Fushin Nan Road, Daling, Dongguan, China. (Zip Code: 523770)
Tel: (86 769) 8111 9066 Fax: (86 769) 8111 8222 E-mail: dgstc@dgstc.org Homepage: www.dgstc.com
This report shall not be reproduced unless with prior written approval from STC (Dongguan) Company Limited.
For Conditions of issuance of this test report, please refer to the overleaf or Homepage.



STC Test Report

Date: 2016-04-01
No.: DMI22443

Page 17 of 60

Results and limit lines for Conducted Emission:
Limits for Conducted Emission Test, please refer to limit lines (Quasi-Peak and Average) in the following diagram.

Results of F Full load and Grid mode (DC 650V) (L3): Pass
Please refer to the following diagram for individual results.

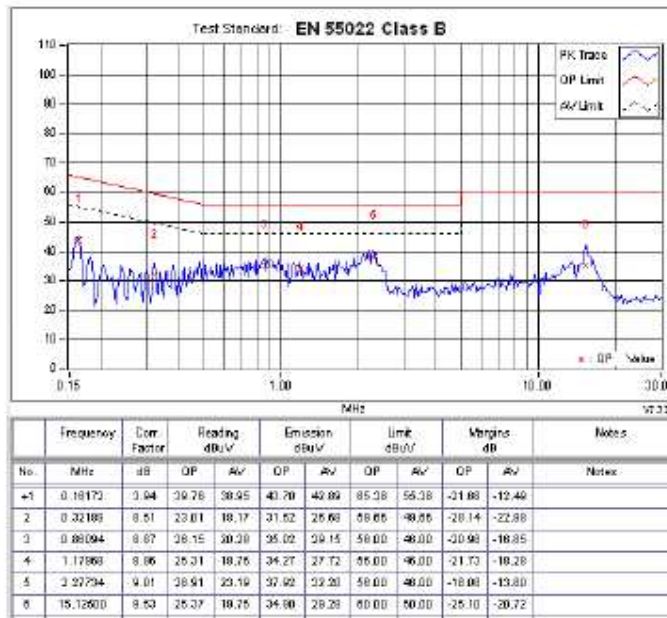

STC (Dongguan) Company Limited

88 Fushin Nan Road, Daling, Dongguan, China. (Zip Code: 523770)
Tel: (+86 769) 8111 9066 Fax: (+86 769) 8111 8222 E-mail: dgstc@dgstc.org Homepage: www.dgstc.org
This report shall not be reproduced unless with prior written approval from STC (Dongguan) Company Limited.
For Conditions of issuance of this test report, please refer to the coverleaf or Homepage.



STC Test Report

Date: 2016-04-01
No.: DMI22443

Page 18 of 60

Results and limit lines for Conducted Emission:

Limits for Conducted Emission Test, please refer to limit lines (Quasi-Peak and Average) in the following diagram.

Results of Full load and Grid mode (DC 650V) (N): Pass
Please refer to the following diagram for individual results.

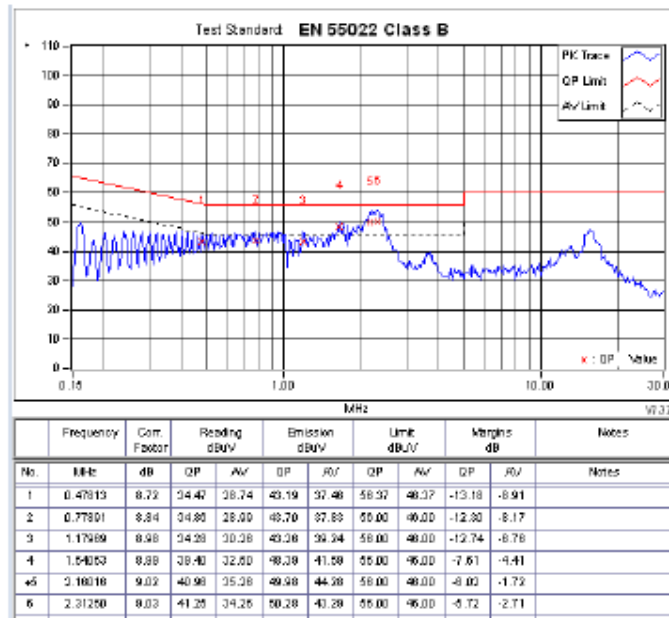

STC (Dongguan) Company Limited

68 Fuzhi Nan Road, Dalang, Dongguan, China. (Zip Code: 523770)
Tel: (86 769) 8111 9668 Fax: (86 769) 8111 8222 E-mail: dgstc@dgstc.org Homepage: www.dgstc.org
This report shall not be reproduced unless with prior written approval from STC (Dongguan) Company Limited.
For Conditions of Issuance of this test report, please refer to the overleaf or Homepage.



STC Test Report

Date: 2016-04-01
No.: DMI22443

Page 19 of 60

Results and limit lines for Conducted Emission:
Limits for Conducted Emission Test, please refer to limit lines (Quasi-Peak and Average) in the following diagram.

Results of Full load and Grid mode (DC 450V) (L1): Pass
Please refer to the following diagram for individual results.

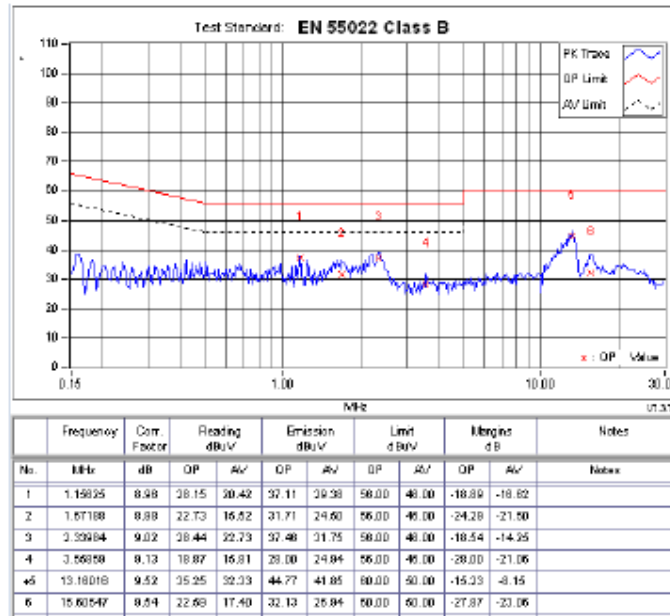

STC (Dongguan) Company Limited

88 Fulin Nan Road, Daxing, Dongguan, China. (Zip Code: 523 770)
Tel: (86 768) 8111 9068 Fax: (86 768) 8111 8222 E-mail: dgstc@dgstc.org Homepage: www.dgstc.com
This report shall not be reproduced unless with prior written approval from STC (Dongguan) Company Limited.
For Conditions of issuance of this test report, please refer to the overleaf or Homepage.



STC Test Report

Date: 2016-04-01
No.: DMI22443

Page 20 of 60

Results and limit lines for Conducted Emission:

Limits for Conducted Emission Test, please refer to limit lines (Quasi-Peak and Average) in the following diagram.

Results of Full load and Grid mode (DC 450V) (L2): Pass

Please refer to the following diagram for individual results.

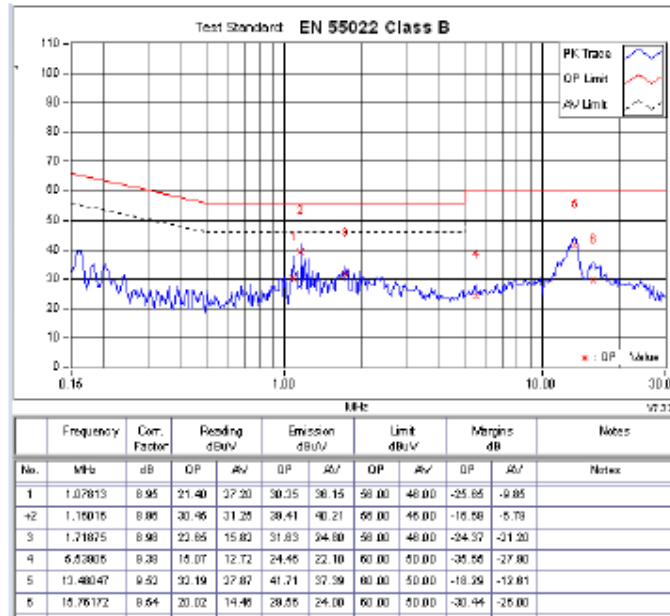

STC (Dongguan) Company Limited

68 Fushin Nan Road, Daling, Dongguan, China. (Zip Code: 523770)
Tel: (86 769) 8111 9668 Fax: (86 769) 8111 8222 E-mail: dgstc@dgstc.org Homepage: www.dgstc.org
This report shall not be reproduced unless with prior written approval from STC (Dongguan) Company Limited.
For Conditions of issuance of this test report, please refer to the overleaf or Homepage.



STC Test Report

Date: 2016-04-01
No.: DM122443

Page 21 of 60

Results and limit lines for Conducted Emission:

Limits for Conducted Emission Test, please refer to limit lines (Quasi-Peak and Average) in the following diagram.

Results of F Full load and Grid mode (DC 450V) (L3): Pass

Please refer to the following diagram for individual results.

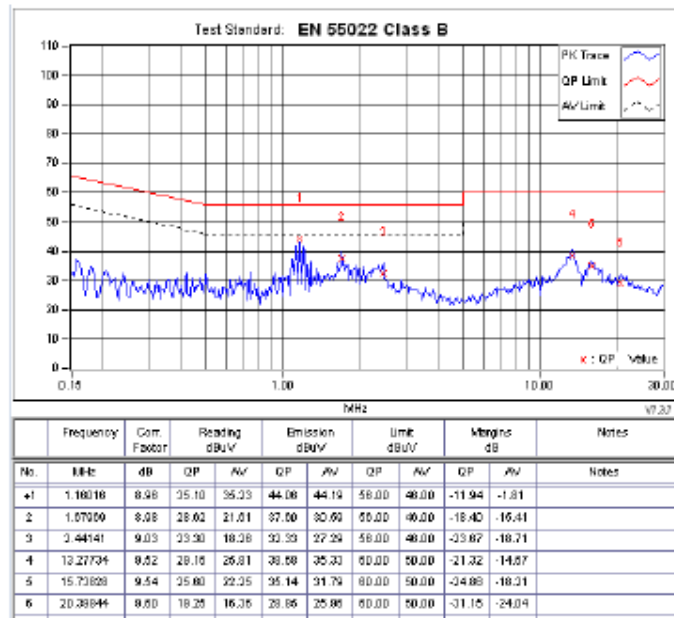

STC (Dongguan) Company Limited

68 Fumin Nan Road, Daling, Dongguan, China. (Zip Code: 523 770)
Tel: (86 769) 8111 9068 Fax: (86 769) 8111 8222 E-mail: dgstc@dgstc.org Homepage: www.dgstc.org
This report shall not be reproduced unless with prior written approval from STC (Dongguan) Company Limited.
For Conditions of Issuance of this test report, please refer to the overleaf or Homepage.



STC Test Report

Date: 2016-04-01
No.: DM122443

Page 22 of 60

Results and limit lines for Conducted Emission:

Limits for Conducted Emission Test, please refer to limit lines (Quasi-Peak and Average) in the following diagram.

Results of Full load and Grid mode (DC 450V) (N): Pass

Please refer to the following diagram for individual results.

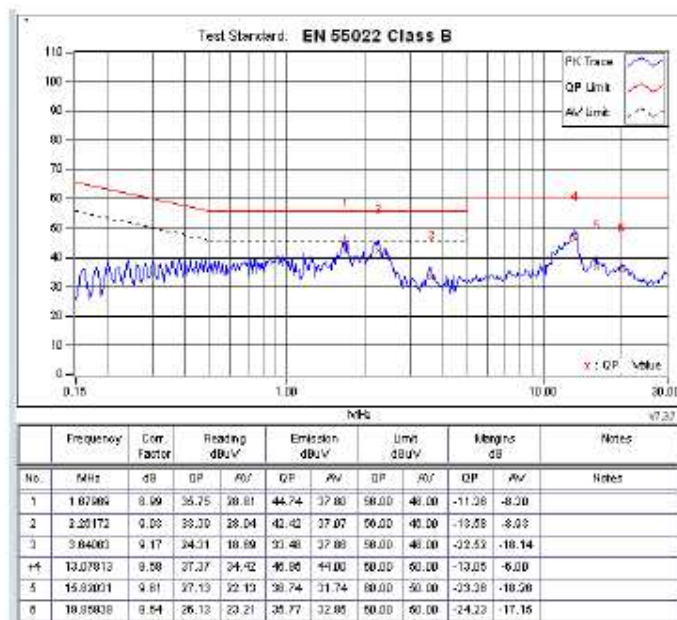

STC (Dongguan) Company Limited

65 Fanchi Nan Road, Daling, Dongguan, China. (Zip Code: 523770)
Tel: (86 769) 8111 9855 Fax: (86 769) 8111 8222 E-mail: dgstc@dgstc.org Homepage: www.dgstc.org
This report shall not be reproduced unless with prior written approval from STC (Dongguan) Company Limited.
For Conditions of Issuance of this test report, please refer to the coverleaf or Homepage.



STC Test Report

Date: 2016-04-01
No.: DM122443

Page 23 of 60

Results and limit lines for Conducted Emission:

Limits for Conducted Emission Test, please refer to limit lines (Quasi-Peak and Average) in the following diagram.

Results of Full load and Grid mode (DC 850V) (L1): Pass

Please refer to the following diagram for individual results.

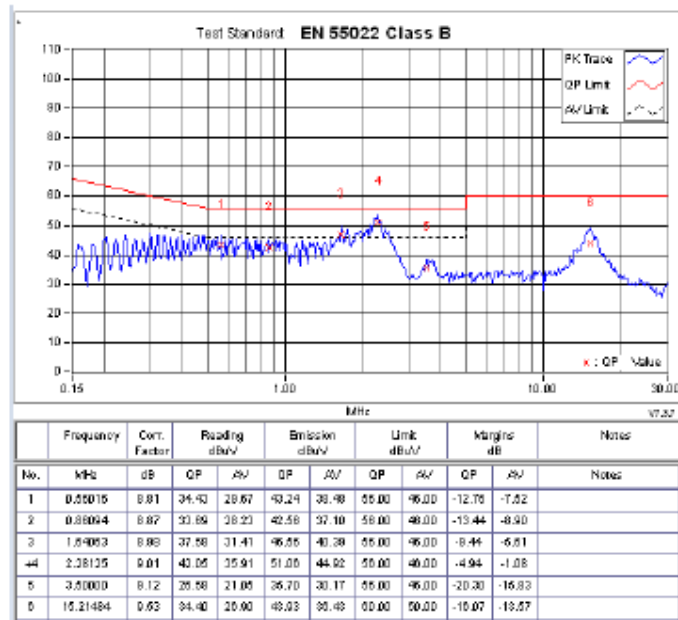

STC (Dongguan) Company Limited

88 Famin Nan Road, Daling, Dongguan, China. (Zip Code: 523 770)
Tel: (86 768) 8111 9668 Fax: (86 768) 8111 0222 E-mail: dgstc@dgstc.org Homepage: www.dgstc.org
This report shall not be reproduced unless with prior written approval from STC (Dongguan) Company Limited.
For Conditions of Issuance of this test report, please refer to the overleaf or Homepage.



STC Test Report

Date: 2016-04-01
No.: DM122443

Page 24 of 60

Results and limit lines for Conducted Emission:
Limits for Conducted Emission Test, please refer to limit lines (Quasi-Peak and Average) in the following diagram.

Results of Full load and Grid mode (DC 850V) (L2): Pass
Please refer to the following diagram for individual results.

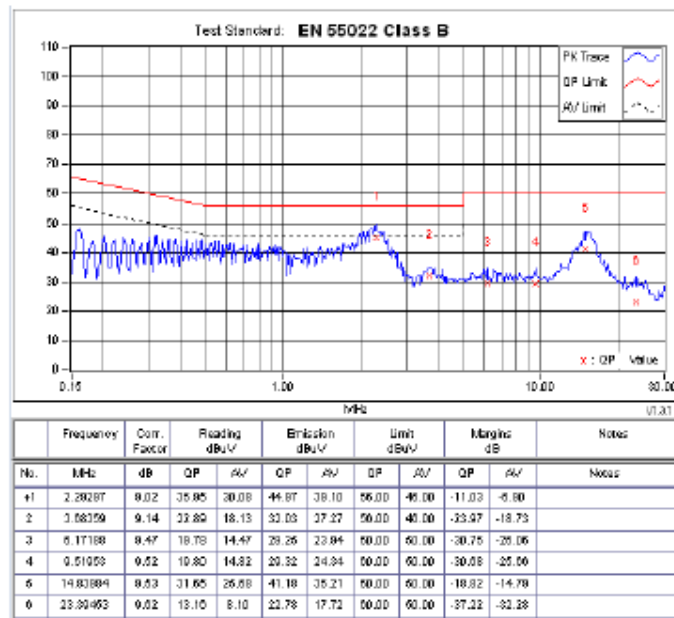

STC (Dongguan) Company Limited

68 Fushan Nan Road, Daling, Dongguan, China. (Zip Code: 523 770)
Tel: (86 769) 8111 9068 Fax: (86 769) 8111 8222 E-mail: dgstc@dgstc.org Homepage: www.dgstc.org
This report shall not be reproduced unless with prior written approval from STC (Dongguan) Company Limited.
For Conditions of Issuance of this test report, please refer to the overleaf or Homepage.



STC Test Report

Date: 2016-04-01
No.: DMI22443

Page 25 of 60

Results and limit lines for Conducted Emission:

Limits for Conducted Emission Test, please refer to limit lines (Quasi-Peak and Average) in the following diagram.

Results of F Full load and Grid mode (DC 850V) (L3): Pass
Please refer to the following diagram for individual results.

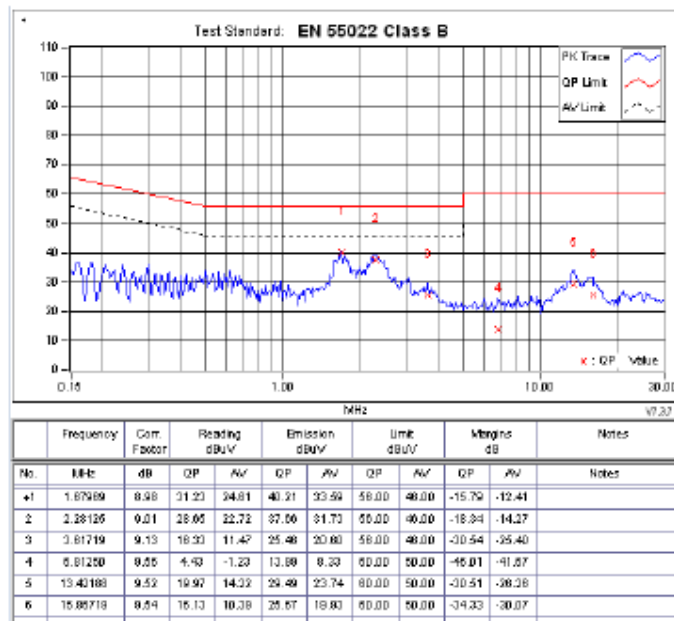

STC (Dongguan) Company Limited

88 Fulin Nan Road, Daxing, Dongguan, China. (Zip Code: 523 770)
Tel: (86 769) 8111 9068 Fax: (86 769) 8111 8222 E-mail: dgstc@dgstc.org Homepage: www.dgstc.com
This report shall not be reproduced unless with prior written approval from STC (Dongguan) Company Limited.
For Conditions of issuance of this test report, please refer to the overleaf or Homepage.



STC Test Report

Date: 2016-04-01
No.: DMI22443

Page 26 of 60

Results and limit lines for Conducted Emission:

Limits for Conducted Emission Test, please refer to limit lines (Quasi-Peak and Average) in the following diagram.

Results of Full load and Grid mode (DC 850V) (N): Pass
Please refer to the following diagram for individual results.

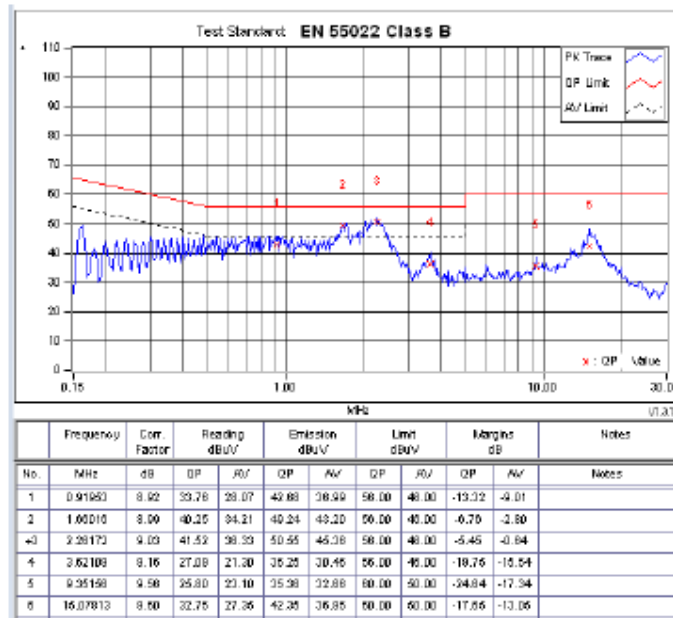

Remark:
Calculated measurement uncertainty (0.15MHz – 30MHz): 3.2dB

STC (Dongguan) Company Limited

88 Famin Nan Road, Daling, Dongguan, China. (Zip Code: 523 770)
Tel: (86 768) 8111 9668 Fax: (86 768) 8111 8222 E-mail: dgstc@dgstc.org Homepage: www.dgstc.org
This report shall not be reproduced unless with prior written approval from STC (Dongguan) Company Limited.
For Conditions of Issuance of this test report, please refer to the overleaf or Homepage.



STC Test Report

Date: 2016-04-01
No.: DMI22443

Page 27 of 60

3.1.3 Harmonic current emissions

Test Requirement: EN 61000-3-2
Test Method: EN 61000-3-2
Level: Class A

Mode of Operation: Sofar 10000TL-Sx Series

Test Method:

The test was performed in accordance with EN 61000-3-2.

Test Procedure:

The EUT is a PV Inverter, the test was conducted during the all modes test function to simulate the normal usage as well as to produce the maximum electromagnetic disturbances.

STC (Dongguan) Company Limited

88 Fanyin Nan Road, Daxing, Dongguan, China. (Zip Code: 523370)
Tel: (86 769) 8111 9666. Fax: (86 769) 8111 0222. E-mail: dgstc@dgstc.org | Homepage: www.dgstc.org
This report shall not be reproduced unless with prior written approval from STC (Dongguan) Company Limited.
For Conditions of Issuance of this test report, please refer to the coverleaf or Homepage.



STC Test Report

Date: 2016-04-01
No.: DMI22443

Page 28 of 60

Results and limit line for Harmonics Emissions:

Results (Model Number: Sofar 10000TL-Sx Series): Pass
Please refer to the following table for individual results.

(Average)

Order	Measure[A]	Limit[A]	Margin[%]	Order	Measure[A]	Limit[A]	Margin[%]
1	14.5987			2	0.0001	1.0000	99.9
3	0.0029	2.3030	98.8	4	0.0011	0.4300	96.7
5	0.0011	1.1400	98.1	6	0.0002	0.3000	97.3
7	0.0011	0.7700	97.5	8	0.0008	0.2300	96.7
9	0.0012	0.4000	97.0	10	0.0008	0.1840	96.4
11	0.0012	0.3300	97.8	12	0.0009	0.1530	96.1
13	0.0009	0.2100	95.4	14	0.0009	0.1314	95.5
15	0.0009	0.1500	95.4	16	0.0007	0.1150	95.0
17	0.0007	0.1024	95.3	18	0.0005	0.1022	94.6
19	0.0005	0.1194	94.9	20	0.0006	0.0920	93.7
21	0.0005	0.1071	93.0	22	0.0005	0.0830	93.1
23	0.0004	0.3078	93.3	24	0.0003	0.0787	92.1
25	0.0003	0.0500	92.5	26	0.0003	0.0700	95.9
27	0.0003	0.0633	91.2	28	0.0002	0.0657	99.6
29	0.0002	0.0775	90.0	30	0.0002	0.0613	98.4
31	0.0001	0.0725	89.0	32	0.0001	0.0575	97.0
33	0.0001	0.0682	87.8	34	0.0001	0.0541	95.5
35	0.0001	0.0643	86.0	36	0.0001	0.0511	94.2
37	0.0001	0.0606	85.0	38	0.0001	0.0484	92.9
39	0.0001	0.0577	84.3	40	0.0001	0.0460	91.5

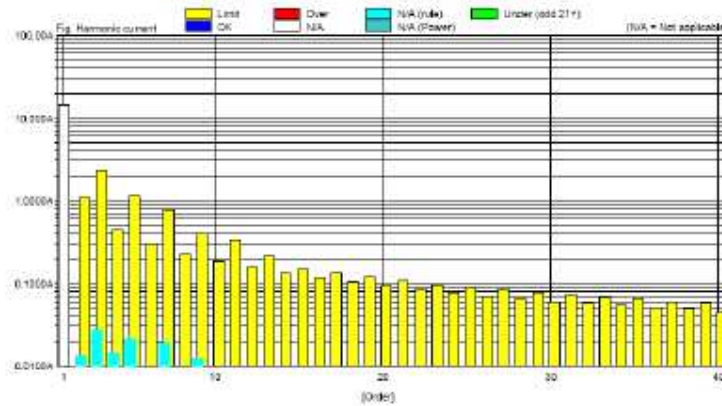

STC (Dongguan) Company Limited

88 Fushan Nan Road, Daxing, Dongguan, China. (Zip Code: 523 770)
Tel: (+86 769) 8111 9666 Fax: (+86 769) 8111 0222 E-mail: dgstc@dgstc.org Homepage: www.dgstc.org
This report shall not be reproduced unless with prior written approval from STC (Dongguan) Company Limited.
For Conditions of issuance of this test report, please refer to the coverleaf or homepage.



STC Test Report

Date: 2016-04-01
No.: DMI22443

Page 29 of 60

Results and limit line for Harmonics Emissions:

Results (Model Number: Sofar 10000TL-Sx Series): Pass
Please refer to the following table for individual results.

(Average)

Order	Measure[A]	Limit[A]	Margin[%]	Order	Measure[A]	Limit[A]	Margin[%]
1	14.5172			2	0.0237	1.0020	80.2
3	0.0102	2.3020	85.9	4	0.0112	0.4320	87.4
5	0.0076	1.1420	97.7	6	0.0082	0.3020	96.1
7	0.0102	0.7700	97.8	8	0.0081	0.2320	97.7
9	0.0077	0.4000	96.1	10	0.0071	0.1840	97.2
11	0.0054	0.3300	98.2	12	0.0042	0.1510	97.2
13	0.0038	0.2100	94.8	14	0.0044	0.1314	96.4
15	0.0029	0.1500	96.0	16	0.0042	0.1150	96.2
17	0.0022	0.1324	95.7	18	0.0031	0.1022	96.2
19	0.0017	0.1184	96.0	20	0.0029	0.0920	95.6
21	0.0013	0.1071	95.2	22	0.0024	0.0836	95.1
23	0.0009	0.0978	95.3	24	0.0021	0.0727	94.6
25	0.0007	0.0900	94.7	26	0.0019	0.0708	92.2
27	0.0006	0.0833	94.2	28	0.0016	0.0657	92.9
29	0.0005	0.0770	92.4	30	0.0015	0.0613	92.2
31	0.0005	0.0728	92.3	32	0.0014	0.0575	91.0
33	0.0004	0.0682	90.8	34	0.0013	0.0541	90.0
35	0.0004	0.0643	88.5	36	0.0012	0.0511	89.7
37	0.0003	0.0608	88.3	38	0.0012	0.0484	87.4
39	0.0003	0.0577	87.2	40	0.0011	0.0460	86.2

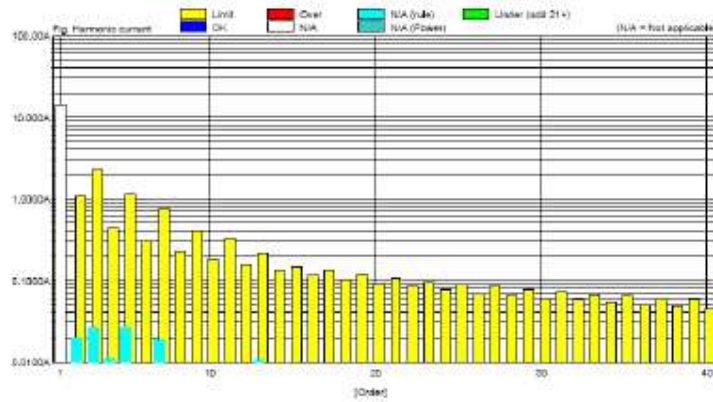

STC (Dongguan) Company Limited

88 Fulin Han Road, Daxing, Dongguan, China. (Zip Code: 523 770)
Tel: (86 769) 8111 9668 Fax: (86 769) 8111 0222 E-mail: dgstc@dgstc.org Homepage: www.dgstc.org
This report shall not be reproduced unless with prior written approval from STC (Dongguan) Company Limited.
For Conditions of issuance of this test report, please refer to the cover sheet or Homepage.



STC Test Report

Date: 2016-04-01
No.: DM122443

Page 30 of 60

Results and limit line for Harmonics Emissions:

Results (Model Number: Sofar 10000TL-Sx Series): Pass
Please refer to the following table for individual results.

(Average)

Order	Measure[A]	Limit[A]	Margin[%]	Order	Measure[A]	Limit[A]	Margin[%]
1	14.3064			2	0.0195	1.0050	99.5
3	0.1752	2.3000	99.4	4	0.0132	0.4300	96.9
5	0.0276	1.1400	97.5	6	0.0082	0.3000	96.2
7	0.0173	0.7100	97.7	8	0.0064	0.2300	97.6
9	0.0237	0.4000	98.1	10	0.0048	0.1840	97.4
11	0.0285	0.3300	97.6	12	0.0042	0.1533	97.3
13	0.0267	0.2100	95.9	14	0.0042	0.1314	97.0
15	0.0244	0.1900	97.1	16	0.0033	0.1150	96.6
17	0.0209	0.1324	94.3	18	0.0027	0.1022	96.4
19	0.0242	0.1184	96.4	20	0.0021	0.0920	95.9
21	0.0246	0.1071	95.7	22	0.0018	0.0836	95.6
23	0.0242	0.0878	95.7	24	0.0017	0.0767	95.1
25	0.0243	0.0900	95.2	26	0.0013	0.0756	94.5
27	0.0267	0.0933	94.5	28	0.0012	0.0657	94.3
29	0.0245	0.0776	94.2	30	0.0010	0.0613	93.7
31	0.0252	0.0728	93.1	32	0.0008	0.0575	93.1
33	0.0242	0.0682	93.7	34	0.0008	0.0541	92.9
35	0.0242	0.0645	93.5	36	0.0008	0.0511	92.6
37	0.0233	0.0608	92.0	38	0.0008	0.0484	91.9
39	0.0248	0.0577	91.5	40	0.0007	0.0460	92.0

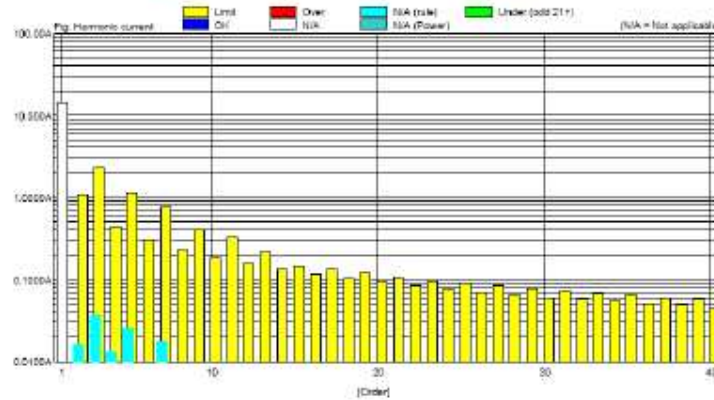

STC (Dongguan) Company Limited

88 Fanchi Nan Road, Daling, Dongguan, China. (Zip Code: 523 770)
Tel.: (86 769) 8111 9600 Fax.: (86 769) 8111 6222 E-mail: dgstc@dgstc.org Homepage: www.dgstc.org
This report shall not be reproduced unless with prior written approval from STC (Dongguan) Company Limited.
For Conditions of Insurance of this test report, please refer to the overleaf or Homepage.



STC Test Report

Date: 2016-04-01
No.: DMI22443

Page 31 of 60

Results and limit line for Harmonics Emissions:

Results (Model Number: Sofar 10000TL-Sx Series): Pass
Please refer to the following table for individual results.

(Maximum)

Order	Measure[A]	Limit[A]	Margin[%]	Order	Measure[A]	Limit[A]	Margin[%]
1	14.5225			2	0.0175	1.8200	98.9
3	0.0225	3.4500	99.3	4	0.0181	0.9450	97.2
5	0.0241	1.7100	98.0	6	0.0161	0.4500	97.7
7	0.0212	1.1550	97.9	8	0.0062	0.3450	97.3
9	0.0195	0.8000	96.8	10	0.0083	0.2760	97.9
11	0.0182	0.4950	97.2	12	0.0073	0.2100	96.8
13	0.0157	0.3150	89.0	14	0.0075	0.1911	96.3
15	0.0134	0.2250	96.4	16	0.0074	0.1725	96.7
17	0.0111	0.1685	96.4	18	0.0067	0.1533	96.6
19	0.0093	0.1779	95.0	20	0.0062	0.1380	96.0
21	0.0087	0.1607	94.8	22	0.0071	0.1255	94.4
23	0.0086	0.1467	94.2	24	0.0073	0.1150	93.5
25	0.0083	0.1350	90.5	26	0.0063	0.1062	90.5
27	0.0083	0.1250	92.6	28	0.0066	0.0988	91.3
29	0.0086	0.1164	90.9	30	0.0064	0.0920	89.9
31	0.0111	0.1069	89.9	32	0.0063	0.0862	88.5
33	0.0112	0.1023	88.8	34	0.0067	0.0812	88.8
35	0.0123	0.0964	88.8	36	0.0075	0.0767	88.0
37	0.0132	0.0912	85.5	38	0.0076	0.0726	83.0
39	0.0134	0.0865	84.5	40	0.0074	0.0690	82.0

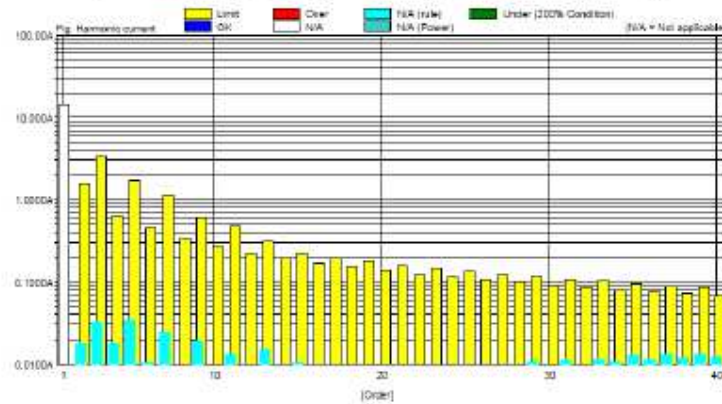

STC (Dongguan) Company Limited

88 Fulin Nan Road, Daling, Dongguan, China. (Zip Code: 523 770)
Tel: (86 769) 8111 9066 Fax: (86 769) 8111 8222 E-mail: dgstc@dgstc.org Homepage: www.dgstc.org
This report shall not be reproduced unless with prior written approval from STC (Dongguan) Company Limited.
For Conditions of issuance of this test report, please refer to the overleaf or Homepage.



STC Test Report

Date: 2016-04-01
No.: DM122443

Page 32 of 60

Results and limit line for Harmonics Emissions:

Results (Model Number: Sofar 10000TL-Sx Series): Pass
Please refer to the following table for individual results.

(Maximum)

Order	Measure(A)	Limit(A)	Margin[%]	Order	Measure(A)	Limit(A)	Margin[%]
1	14.5234			2	0.0289	1.8200	98.2
3	0.2350	3.4500	99.0	4	0.0165	0.6400	97.4
5	0.2201	1.7100	97.7	6	0.0201	0.4500	95.0
7	0.2253	1.1650	97.8	8	0.0386	0.3450	97.5
9	0.2158	0.8000	97.4	10	0.0278	0.2700	67.2
11	0.2114	0.4950	97.7	12	0.0098	0.2300	97.0
13	0.2192	0.3150	94.7	14	0.0095	0.1971	96.6
15	0.2116	0.2250	94.8	16	0.0087	0.1725	98.1
17	0.2110	0.1980	94.4	18	0.0085	0.1533	95.9
19	0.2105	0.1776	94.1	20	0.0081	0.1380	95.5
21	0.2079	0.1607	95.1	22	0.0084	0.1255	94.9
23	0.2054	0.1467	93.8	24	0.0084	0.1150	94.4
25	0.2032	0.1350	94.0	26	0.0077	0.1062	91.1
27	0.2031	0.1250	93.5	28	0.0075	0.0986	92.6
29	0.2008	0.1184	91.7	30	0.0078	0.0920	91.5
31	0.2003	0.1098	91.5	32	0.0084	0.0902	90.3
33	0.2102	0.1023	90.0	34	0.0087	0.0812	89.3
35	0.2113	0.0954	88.3	36	0.0095	0.0757	87.6
37	0.2111	0.0912	87.9	38	0.0099	0.0724	86.3
39	0.2118	0.0805	86.6	40	0.0104	0.0690	85.0

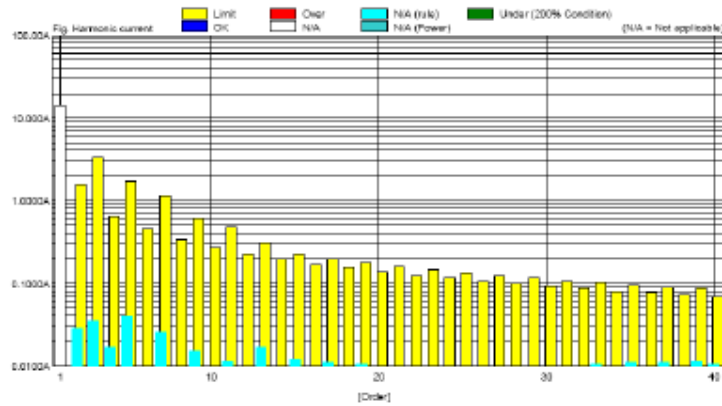

STC (Dongguan) Company Limited

68 Fushin Nan Road, Daling, Dongguan, China. (Zip Code: 523 770)
Tel: (86 769) 8111 9068 Fax: (86 769) 8111 0222 E-mail: dgstc@dgstc.org Homepage: www.dgstc.org
This report shall not be reproduced unless with prior written approval from STC (Dongguan) Company Limited.
For Conditions of Issuance of this test report, please refer to the overleaf or Homepage.



STC Test Report

Date: 2016-04-01
No.: DMI22443

Page 33 of 60

Results and limit line for Harmonics Emissions:

Results (Model Number: Sofar 10000TL-Sx Series): Pass
Please refer to the following table for individual results.

(Maximum)

Order	Measure(A)	Limit(A)	Margin(%)	Order	Measure(A)	Limit(A)	Margin(%)
1	14.5120			2	0.0027	1.6200	80.6
3	0.0025	3.4500	99.8	4	0.0011	0.5450	87.3
5	0.0018	1.1100	97.7	6	0.0008	0.4500	98.5
7	0.0011	1.1500	95.1	8	0.0005	0.3450	99.0
9	0.0007	0.6000	99.8	10	0.0003	0.2760	97.8
11	0.0004	0.4950	98.2	12	0.0002	0.2300	97.6
13	0.0002	0.3150	96.7	14	0.0001	0.1971	97.4
15	0.0001	0.2250	97.4	16	0.0001	0.1725	97.2
17	0.0001	0.1905	95.7	18	0.0001	0.1533	97.1
19	0.0001	0.1776	96.8	20	0.0001	0.1380	96.7
21	0.0001	0.1607	96.2	22	0.0001	0.1255	96.5
23	0.0001	0.1467	96.4	24	0.0001	0.1152	99.0
25	0.0001	0.1350	98.9	26	0.0001	0.1052	97.7
27	0.0001	0.1250	95.6	28	0.0001	0.0985	95.0
29	0.0001	0.1164	94.8	30	0.0001	0.0920	94.5
31	0.0001	0.1089	94.1	32	0.0001	0.0862	94.0
33	0.0001	0.1023	94.5	34	0.0001	0.0812	93.8
35	0.0001	0.0964	93.9	36	0.0001	0.0767	93.4
37	0.0001	0.0912	93.3	38	0.0001	0.0725	92.9
39	0.0001	0.0865	93.1	40	0.0001	0.0680	92.8

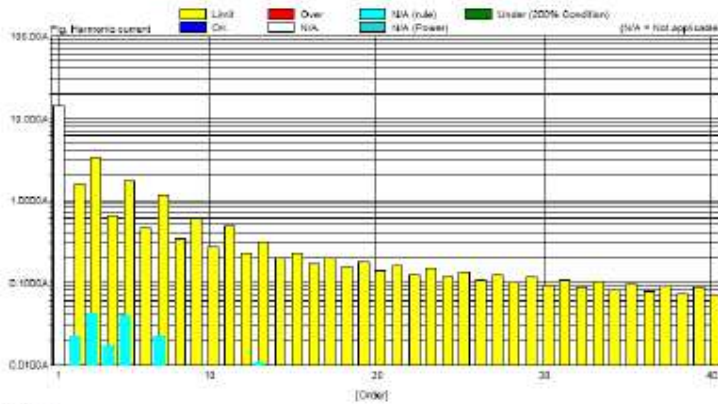

Remark:
Calculated measurement uncertainty: 7.11%

STC (Dongguan) Company Limited

88 Fushin Nan Road, Daling, Dongguan, China. (Zip Code: 523 770)
Tel: (86 769) 8111 9888 Fax: (86 769) 8111 0222 E-mail: dgstc@dgstc.org Homepage: www.dgstc.org
This report shall not be reproduced unless with prior written approval from STC (Dongguan) Company Limited.
For Conditions of issuance of this test report, please refer to the coverleaf or homepage.



STC Test Report

Date: 2016-04-01
No.: DMI22443

Page 34 of 60

3.1.4 Harmonic current emissions

Test Requirement: EN 61000-3-12
Test Method: EN 61000-3-12
Level: Stage 2

Mode of Operation: Sofar 20000TL-Sx Series.

Test Method:

The test was performed in accordance with EN 61000-3-12.

Test Procedure:

The EUT is a PV Inverter, the test was conducted during the all modes test function to simulate the normal usage as well as to produce the maximum electromagnetic disturbances.

STC (Dongguan) Company Limited

88 Fumin Nan Road, Cailing, Dongguan, China. (Zip Code: 523 770)
Tel: (86 768) 8111 9666. Fax: (86 768) 8111 0222. E-mail: dgstc@dgstc.org Homepage: www.dgstc.org
This report shall not be reproduced unless with prior written approval from STC (Dongguan) Company Limited.
For Conditions of Issuance of this test report, please refer to the overleaf or Homepage.



STC Test Report

Date: 2016-04-01
No.: DMI22443

Page 35 of 60

Results and limit line for Harmonics Emissions:

Results (Model Number: Sofar 20000TL-Sx Series): Pass
Please refer to the following table for individual results.

(Average)

Order	Measure[%]	Limit[%]	Margin[%]
2	0.1850	8.0000	97.9
3	0.0811	21.0000	99.6
4	0.1405	4.0000	96.5
5	0.0296	11.0000	94.4
6	0.0079	2.6667	96.6
7	0.4157	7.0000	94.3
8	0.0665	2.0000	96.7
9	0.0808	3.0000	96.4
10	0.1160	1.0000	92.8
11	0.1358	3.1600	95.7
12	0.0237	1.1000	98.3
13	0.2387	2.0000	96.0
THD	0.3653	23.4750	96.0
PWHD	1.8879	29.4750	92.1

(Maximum)

Order	Measure[%]	Limit[%]	Margin[%]
2	0.2057	12.0000	98.3
3	0.1071	12.9700	99.7
4	0.1075	6.0000	99.9
5	0.1903	16.9800	95.5
6	0.1044	4.0000	98.9
7	0.5088	10.9875	95.1
8	0.1051	3.0000	97.1
9	0.0808	5.7375	98.8
10	0.1087	2.4000	94.3
11	0.1021	4.7400	96.8
12	0.0208	2.0000	98.7
13	0.2025	3.0900	98.2
THD	1.1070	35.2125	96.9
PWHD	2.0643	35.2125	94.1

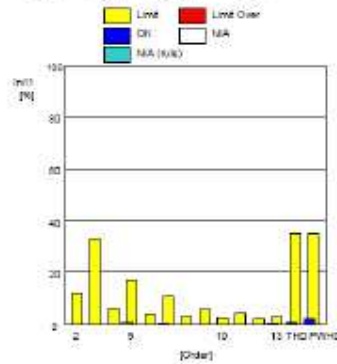
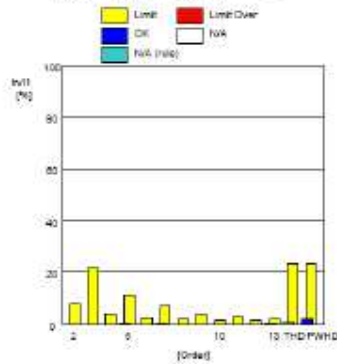

STC (Dongguan) Company Limited

88 Fushan Nan Road, Daxing, Dongguan, China. (Zip Code: 523 770)
Tel: (86 769) 8111 9668 Fax: (86 769) 8111 0322 E-mail: dgstc@dgstc.org Homepage: www.dgstc.org
This report shall not be reproduced unless with prior written approval from STC (Dongguan) Company Limited.
For Conditions of issuance of this test report, please refer to the cover sheet or Homepage.



STC Test Report

Date: 2016-04-01
No.: DMI22443

Page 36 of 60

Results and limit line for Harmonics Emissions:

Results (Model Number: Sofar 20000TL-Sx Series): Pass
Please refer to the following table for individual results.

(Average)

Order	Measure[%]	Limit[%]	Margin[%]
2	0.2453	8.0000	97.3
3	0.0709	21.8000	96.7
4	0.1542	4.0000	96.1
5	0.0298	11.3200	94.7
6	0.0347	2.6667	98.7
7	0.0342	7.3200	94.8
8	0.0262	2.0000	97.1
9	0.0376	3.0200	98.5
10	0.1437	1.8000	92.9
11	0.1409	3.1800	95.4
12	0.0229	1.3333	98.3
13	0.2711	2.0800	96.7
THD	0.9321	23.4750	96.1
DWHD	1.7888	23.4750	92.4

(Maximum)

Order	Measure[%]	Limit[%]	Margin[%]
2	0.2554	12.0000	97.9
3	0.3201	32.5000	99.7
4	0.2014	8.0000	95.8
5	0.2413	18.9800	95.8
6	0.0444	4.0000	98.9
7	0.0269	10.5675	95.4
8	0.0298	2.0000	97.5
9	0.0547	2.7375	95.9
10	0.1541	2.4000	94.4
11	0.0898	4.7400	98.4
12	0.0301	2.0000	98.5
13	0.2678	3.0800	93.7
THD	1.1190	11	95.2
DWHD	1.9074	35.2125	94.3

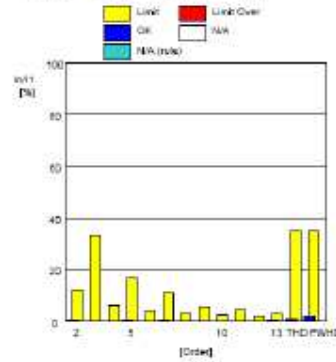
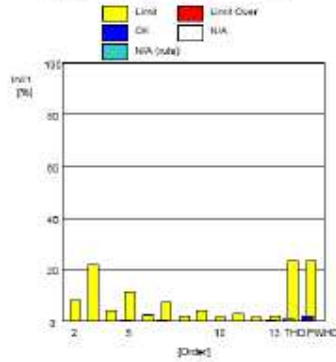

STC (Dongguan) Company Limited

88 Famin Han Road, Daxing, Dongguan, China. (Zip Code: 523 770)
Tel: (86 769) 8111 9668 Fax: (86 769) 8111 0222 E-mail: dgstc@dgstc.org Homepage: www.dgstc.org
This report shall not be reproduced unless with prior written approval from STC (Dongguan) Company Limited.
For Conditions of Issuance of this test report, please refer to the overleaf or Homepage.



STC Test Report

Date: 2016-04-01
No.: DM122443

Page 37 of 60

Results and limit line for Harmonics Emissions:

Results (Model Number: Sofar 20000TL-Sx Series): Pass
Please refer to the following table for individual results.

(Average)

Order	Measure[%]	Limit[%]	Margin[%]
2	0.1864	8.0000	97.6
3	0.0911	21.9900	99.7
4	0.1220	4.0000	96.9
5	0.0841	11.3200	94.1
6	0.0448	2.8800	98.3
7	0.2347	7.3200	95.4
8	0.0837	2.0000	95.3
9	0.0123	3.0200	99.2
10	0.1200	1.6000	92.0
11	0.1128	3.1600	96.4
12	0.0200	1.3300	86.1
13	0.2509	2.0600	87.8
THD	0.5038	23.4750	96.0
PWHD	1.7891	21.4750	92.3

(Maximum)

Order	Measure[%]	Limit[%]	Margin[%]
2	0.2260	10.0000	98.1
3	0.0947	32.6700	99.7
4	0.1000	6.0000	97.4
5	0.7500	16.6000	95.3
6	0.0300	4.0000	98.5
7	0.4070	10.9875	95.8
8	0.1070	3.0000	96.4
9	0.0400	3.7375	99.0
10	0.1400	2.4000	94.2
11	0.1290	4.7400	97.3
12	0.0300	2.0000	98.0
13	0.2000	3.0900	91.3
THD	1.1883	30.2125	96.9
PWHD	1.6968	30.2125	94.9

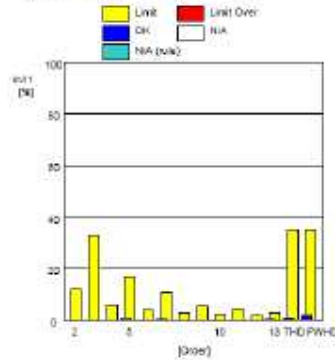
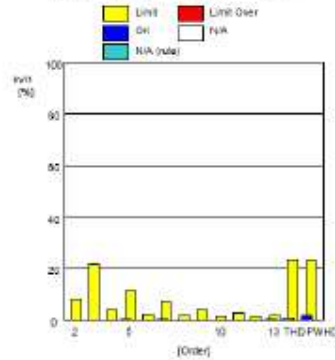

Remark:
Calculated measurement uncertainty: 7.11%

STC (Dongguan) Company Limited

88 Fushan Nan Road, Dongguan, Dongguan, China. (Zip Code: 523 770).
Tel: (86 768) 8111 8868. Fax: (86 768) 8111 8222. E-mail: dgstc@dgstc.org. Homepage: www.dgstc.com
This report shall not be reproduced unless with prior written approval from STC (Dongguan) Company Limited.
For Conditions of Issuance of this test report, please refer to the overleaf or Homepage.



STC Test Report

Date: 2016-04-01
No.: DMI22443

Page 38 of 60

3.1.5 Voltage fluctuations & Flicker

Test Requirement:	EN 61000-3-3
Test Method:	EN 61000-3-3
Limits:	Pst=1 d _c (%)=3.3% d _{Max} (%)=4% d _t (t)>3.3%≤500ms

Mode of Operation: Sofar 10000TL-Sx Series

Test Method:

The test was performed in accordance with EN 61000-3-3.

Test Procedure:

The EUT is a PV Inverter, the test was conducted during the all modes test function to simulate the normal usage as well as to produce the maximum electromagnetic disturbances.

STC (Dongguan) Company Limited

88 Famin Han Road, Daling, Dongguan, China. (Zip Code: 523 770)
Tel: (86 769) 8111 9666 Fax: (86 769) 8111 0222 E-mail: dgstc@dgstc.org Homepage: www.dgstc.org
This report shall not be reproduced unless with prior written approval from STC (Dongguan) Company Limited.
For Conditions of Issuance of this test report, please refer to the overleaf or Homepage.



STC Test Report

Date: 2016-04-01
No.: DMI22443

Page 39 of 60

Limits for Flicker:
Please refer to the result table for details.

Results (Model Number: Sofar 10000TL-Sr Series): Pass
Please refer to the following table for individual results.

No.	dc[%]	dmax[%]	d1(ms)	Pst
1	0.00	0.00	0.00	0.07
2	0.00	0.00	0.00	0.07
3	0.00	0.00	0.00	0.07
4	0.00	0.00	0.00	0.07
5	0.00	0.00	0.00	0.07
6	0.00	0.00	0.00	0.07
7	0.00	0.00	0.00	0.07
8	0.00	0.00	0.00	0.07
9	0.00	0.00	0.00	0.07
10	0.00	0.00	0.00	0.07
11	0.00	0.00	0.00	0.07
12	0.00	0.00	0.00	0.07

Pst
0.07

No.	dc[%]	dmax[%]	d1(ms)	Pst
1	0.00	0.00	0.00	0.07
2	0.00	0.00	0.00	0.07
3	0.00	0.00	0.00	0.07
4	0.00	0.00	0.00	0.07
5	0.00	0.00	0.00	0.07
6	0.00	0.00	0.00	0.07
7	0.00	0.00	0.00	0.07
8	0.00	0.00	0.00	0.07
9	0.00	0.00	0.00	0.07
10	0.00	0.00	0.00	0.07
11	0.00	0.00	0.00	0.07
12	0.00	0.00	0.00	0.07

Pst
0.07

No.	dc[%]	dmax[%]	d1(ms)	Pst
1	0.00	0.00	0.00	0.07
2	0.00	0.00	0.00	0.07
3	0.00	0.00	0.00	0.07
4	0.00	0.00	0.00	0.07
5	0.05	0.10	0.00	0.07
6	0.00	0.00	0.00	0.07
7	0.00	0.00	0.00	0.07
8	0.00	0.00	0.00	0.07
9	0.00	0.00	0.00	0.07
10	0.00	0.00	0.00	0.07
11	0.00	0.00	0.00	0.07
12	0.00	0.00	0.00	0.07

Pst
0.07

Remarks:
Calculated measurement uncertainty: 7.7%

STC (Dongguan) Company Limited

88 Fulin Nan Road, Daling, Dongguan, China. (Zip Code: 523 770)
Tel: (86 769) 8111 9066 Fax: (86 769) 8111 8222 E-mail: dgstc@dgstc.org Homepage: www.dgstc.org
This report shall not be reproduced unless with prior written approval from STC (Dongguan) Company Limited.
For Conditions of issuance of this test report, please refer to the overleaf or Homepage.



STC Test Report

Date: 2016-04-01
No.: DMI22443

Page 40 of 60

3.1.6 Voltage fluctuation: & Flicker

Test Requirement:	EN 61000-3-11
Test Method:	EN 61000-3-11
Limits:	Pst=1 dc(%)=3.3% dMax(%)=4% d(t)->3.3%=500ms

Mode of Operation: Sofar 20000TL-Sx Series.

Test Method:

The test was performed in accordance with EN 61000-3-11.

Test Procedure:

The EUT is an inverter, the test was conducted during the grid test function to simulate the normal usage as well as to produce the maximum electromagnetic disturbances.

STC (Dongguan) Company Limited

88 Fanyin Nan Road, Daling, Dongguan, China. (Zip Code: 523370)
Tel: (86 769) 8111 9866. Fax: (86 769) 8111 0222. E-mail: dqstc@dqstc.org | Homepage: www.dqstc.org
This report shall not be reproduced unless with prior written approval from STC (Dongguan) Company Limited.
For Conditions of issuance of this test report, please refer to the coverleaf or Homepage.



STC Test Report

Date: 2016-04-01
No.: DMI22443

Page 41 of 60

Limits for Flicker:
Please refer to the result table for details.

Results (Model Number: Sofar 20000TL-Sr Series): Pass
Please refer to the following table for individual results.

No.	dc[%]	dmax[%]	d(t)[ms]	Pst
1	0.19	0.27	0.00	0.11
2	0.19	0.30	0.00	0.12
3	0.18	0.28	0.00	0.11
4	0.17	0.29	0.00	0.11
5	0.18	0.28	0.00	0.11
6	0.18	0.27	0.00	0.11
7	0.19	0.27	0.00	0.11
8	0.18	0.27	0.00	0.11
9	0.19	0.27	0.00	0.11
10	0.12	0.20	0.00	0.07
11	0.08	0.12	0.00	0.07
12	0.01	0.10	0.00	0.07

Pst
0.11

No.	dc[%]	dmax[%]	d(t)[ms]	Pst
1	0.21	0.22	0.00	0.12
2	0.20	0.22	0.00	0.12
3	0.20	0.22	0.00	0.12
4	0.21	0.22	0.00	0.12
5	0.22	0.22	0.00	0.12
6	0.20	0.22	0.00	0.12
7	0.20	0.22	0.00	0.12
8	0.20	0.22	0.00	0.12
9	0.20	0.22	0.00	0.11
10	0.19	0.21	0.00	0.07
11	0.07	0.10	0.00	0.07
12	0.08	0.10	0.00	0.07

Pst
0.11

No.	dc[%]	dmax[%]	d(t)[ms]	Pst
1	0.24	0.24	0.00	0.11
2	0.21	0.24	0.00	0.12
3	0.19	0.24	0.00	0.11
4	0.19	0.24	0.00	0.11
5	0.20	0.24	0.00	0.11
6	0.20	0.24	0.00	0.11
7	0.20	0.24	0.00	0.11
8	0.19	0.24	0.00	0.11
9	0.20	0.24	0.00	0.11
10	0.13	0.20	0.00	0.07
11	0.04	0.10	0.00	0.07
12	0.04	0.10	0.00	0.07

Pst
0.11

Remarks:
Calculated measurement uncertainty: 7.7%

STC (Dongguan) Company Limited

88 Fulin Nan Road, Daling, Dongguan, China. (Zip Code: 523770)
Tel: (86 769) 8111 9066 Fax: (86 769) 8111 8222 E-mail: dgstc@dgstc.org Homepage: www.dgstc.org
This report shall not be reproduced unless with prior written approval from STC (Dongguan) Company Limited.
For Conditions of issuance of this test report, please refer to the overleaf or Homepage.



STC Test Report

Date: 2016-04-01
No.: DMI22443

Page 42 of 60

3.2 Immunity

3.2.1 Susceptibility Performance Criteria

A	The apparatus shall continue to operate as intended during and after the test. No degradation of performance or loss of function is allowed below a performance level specified by the manufacturer, when the apparatus is used as intended. The performance level may be replaced by a permissible loss of performance. If the minimum performance level or the permissible performance loss is not specified by the manufacturer, either of these may be derived from the product description and documentation and what the user may reasonably expect from the apparatus if used as intended.
B	The apparatus shall continue to operate as intended after the test. No degradation of performance or loss of function is allowed below a performance level specified by the manufacturer, when the apparatus is used as intended. The performance level may be replaced by a permissible loss of performance. During the test, degradation of performance is however allowed. No change of actual operating state or stored data is allowed. If the minimum performance level or the permissible performance loss is not specified by the manufacturer, either of these may be derived from the product description and documentation and what the user may reasonably expect from the apparatus if used as intended.
C	Temporary loss of function is allowed, provided the function is self-recoverable or can be restored by the operation of the controls.
D	Degradation or loss of function which is not recoverable due to damage of equipment (components) or software, or loss of data

STC (Dongguan) Company Limited

88 Fumin Nan Road, Daxiang, Dongguan, China. (Zip Code: 523 770).
Tel: (86 768) 8111 9666. Fax: (86 768) 8111 0222. E-mail: dgstc@dgstc.org. Homepage: www.dgstc.org
This report shall not be reproduced unless with prior written approval from STC (Dongguan) Company Limited.
For Conditions of Issuance of this test report, please refer to the overleaf or Homepage.



STC Test Report

Date: 2016-04-01
No.: DMI22443

Page 43 of 60

3.2.2 Electrostatic Discharge

Test Requirement: IEC 61000-4-2
Test Method: IEC 61000-4-2
Severity: $\pm 2kV, \pm 4kV, \pm 6kV$ for Direct & Indirect Contact Discharge
 $\pm 2kV, \pm 4kV, \pm 8kV$ for Air Discharge

Performance Criterion Requirement: B

Temperature: 23.1 °C
Humidity: 52.4 %
Atmospheric Pressure: 101.5 kPa

Test Date(s): 2016-03-22

Mode of Operation: 10% load mode

Test Method:

The test was performed in accordance with IEC 61000-4-2.

Test Procedure:

The EUT is a PV Inverter, the test was conducted during the 10% load test function to simulate the normal usage specified by the manufacturer.

Test Setup:

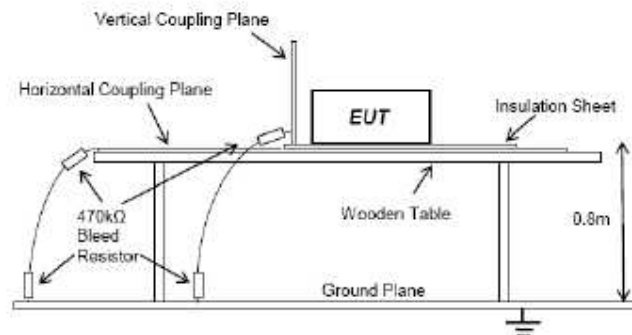

STC (Dongguan) Company Limited

88 Fushin Nan Road, Daling, Dongguan, China. (Zip Code: 523 770)
Tel: (86 769) 8111 9066 Fax: (86 769) 8111 8222 E-mail: dgstc@dgstc.org Homepage: www.dgstc.org
This report shall not be reproduced unless with prior written approval from STC (Dongguan) Company Limited.
For Conditions of issuance of this test report, please refer to the coverleaf or Homepage.



STC Test Report

Date: 2016-04-01
No.: DMI22443

Page 44 of 60

Severity Levels for Electrostatic Discharge:

Level	Test Voltage Direct & Indirect Contact Discharge	Test Voltage Air Discharge
1	±2kV	±2kV
2	±4kV	±4kV
3	±6kV	±6kV
4	±8kV	±15kV

Results: Pass

Please refer to the following table for individual results:

Location	Discharge Method	Test Voltage	Individual Results	
			Pass	Failed
HCP [Horizontal Coupling Plane]	Indirect Contact	±2kV, ±4kV, ±6kV	<input checked="" type="checkbox"/>	<input type="checkbox"/>
VCP [Vertical Coupling Plane]	Indirect Contact	±2kV, ±4kV, ±6kV	<input checked="" type="checkbox"/>	<input type="checkbox"/>
All Metal Parts	Direct Contact	±2kV, ±4kV, ±6kV	<input checked="" type="checkbox"/>	<input type="checkbox"/>
All Non-Metal Parts	Air	±2kV, ±4kV, ±8kV	<input checked="" type="checkbox"/>	<input type="checkbox"/>
***EUT Grounding			<input checked="" type="checkbox"/> Grounded	<input type="checkbox"/> Ungrounded

Remarks:

***For ungrounded EUT, the charge on the EUT shall be removed prior to each applied ESD pulse
Calculated measurement uncertainty: 7.1%

STC (Dongguan) Company Limited

88 Fushin Nan Road, Daling, Dongguan, China. (Zip Code: 523770)
Tel: (86 769) 8111 9066 Fax: (86 769) 8111 8222 E-mail: dgstc@dgstc.org Homepage: www.dgstc.org
This report shall not be reproduced unless with prior written approval from STC (Dongguan) Company Limited.
For Conditions of issuance of this test report, please refer to the coverleaf or Homepage.



STC Test Report

Date: 2016-04-01
No.: DMI22443

Page 45 of 60

3.2.3 Radiated Immunity [80MHz to 1000MHz, 1400-2000MHz, 2000-2700MHz]

Test Requirement: IEC 61000-4-3
Test Method: IEC 61000-4-3
Severity: Level 3 [10V/m]
Modulation: 80% 1kHz AM

Performance Criterion Requirement: A

Temperature: 22.4 °C
Humidity: 55.6 %

Test Date(s): 2016-03-22

Mode of Operation: 10% load mode

Test Method:

The test was performed in accordance with IEC 61000-4-3.

Test Procedure:

The EUT is a PV Inverter, the test was conducted during the 10% load test function to simulate the normal usage specified by the manufacturer.

Test Setup:

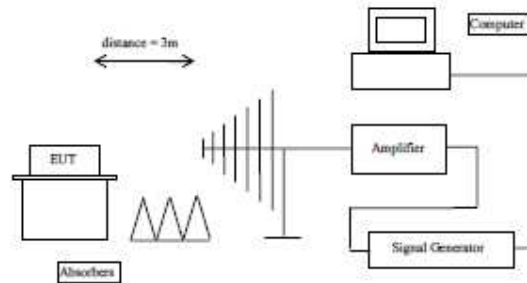

STC (Dongguan) Company Limited

88 Fushin Nan Road, Daling, Dongguan, China. (Zip Code: 523 770)
Tel: (86 769) 8111 9066 Fax: (86 769) 8111 8222 E-mail: dgstc@dgstc.org Homepage: www.dgstc.org
This report shall not be reproduced unless with prior written approval from STC (Dongguan) Company Limited.
For Conditions of issuance of this test report, please refer to the overleaf or Homepage.



STC Test Report

Date: 2016-04-01
No.: DMI22443

Page 46 of 60

Severity Levels for Radiated Immunity:

Level	Field Strength [V/m]
1	1
2	3
3	10

Results: Pass

Please refer to the following table for individual results.

Frequency (MHz)	Face	Polarity	Level (V/m)	Dwell Time (s)	Sweep rate (%)	Individual Results	
						Pass	Failed
80-1000	0°, 90°, 180°, 270°	Horizontal	10	3	1	<input checked="" type="checkbox"/>	<input type="checkbox"/>
1400-2000	0°, 90°, 180°, 270°	Horizontal	10	3	1	<input checked="" type="checkbox"/>	<input type="checkbox"/>
2000-2700	0°, 90°, 180°, 270°	Horizontal	10	3	1	<input checked="" type="checkbox"/>	<input type="checkbox"/>
80-1000	0°, 90°, 180°, 270°	Vertical	10	3	1	<input checked="" type="checkbox"/>	<input type="checkbox"/>
1400-2000	0°, 90°, 180°, 270°	Vertical	10	3	1	<input checked="" type="checkbox"/>	<input type="checkbox"/>
2000-2700	0°, 90°, 180°, 270°	Vertical	10	3	1	<input checked="" type="checkbox"/>	<input type="checkbox"/>

Remarks:

The dwell time at each frequency is according to the standard being applied and the basic standard
Calculated measurement uncertainty: 1.74dB

STC (Dongguan) Company Limited

88 Fushin Nan Road, Daling, Dongguan, China. (Zip Code: 523770)
Tel: (+86 769) 8111 9066 Fax: (+86 769) 8111 8222 E-mail: dgstc@dgstc.org Homepage: www.dgstc.org
This report shall not be reproduced unless with prior written approval from STC (Dongguan) Company Limited.
For Conditions of Issuance of this test report, please refer to the coverleaf or Homepage.



STC Test Report

Date: 2016-04-01
No.: DMI22443

Page 47 of 60

3.2.4 Electrical Fast Transients	
Test Requirement:	IEC 61000-4-4
Test Method:	IEC 61000-4-4
Severity:	Level 3 [$\pm 2kV$]
Performance Criterion Requirement: B	
Temperature:	22.4 °C
Humidity:	56.3 %
Test Date(s):	2016-03-22
Mode of Operation:	10% load mode

Test Method:
The test was performed in accordance with IEC 61000-4-4.

Test Procedure:
The EUT is a PV Inverter, the test was conducted during the 10% load test function to simulate the normal usage specified by the manufacturer.

Test Setup:

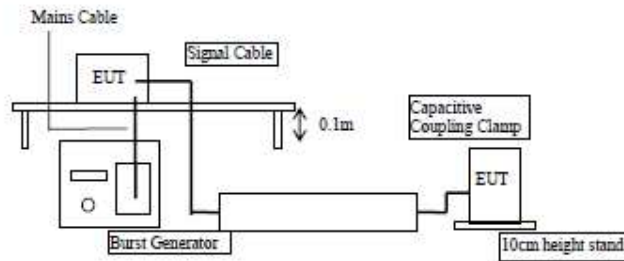

STC (Dongguan) Company Limited

88 Fumin Nan Road, Daling, Dongguan, China. (Zip Code: 523 770)
Tel: (86 769) 8111 8066 Fax: (86 769) 8111 8333 E-mail: dgstc@dgstc.org Homepage: www.dgstc.org
This report shall not be reproduced unless with prior written approval from STC (Dongguan) Company Limited.
For Conditions of Issuance of this test report, please refer to the overleaf or Homepage.



STC Test Report

Date: 2016-04-01
No.: DMI22443

Page 48 of 60

Severity Levels for Electrical Fast Transient:

Level	On power supply port, PE		On I/O (Input/Output) signal, data and control ports	
	Voltage peak [kV]	Repetition rate [kHz]	Voltage peak [kV]	Repetition rate [kHz]
1	0.5	5.0	0.25	5.0
2	1.0	5.0	0.50	5.0
3	2.0	5.0	1.00	5.0
4	4.0	2.5	2.00	5.0

Results: Pass

Please refer to the following table for individual results:

Conductor	Polarity & Level	Duration/Polarity (s)	Individual Results	
			Pass	Failed
Live1	±2kV	120	<input checked="" type="checkbox"/>	<input type="checkbox"/>
Live2	±2kV	120	<input checked="" type="checkbox"/>	<input type="checkbox"/>
Live3	±2kV	120	<input checked="" type="checkbox"/>	<input type="checkbox"/>
Neutral	±2kV	120	<input checked="" type="checkbox"/>	<input type="checkbox"/>
PE	±2kV	120	<input checked="" type="checkbox"/>	<input type="checkbox"/>
Live1- Neutral	±2kV	120	<input checked="" type="checkbox"/>	<input type="checkbox"/>
Live2- Neutral	±2kV	120	<input checked="" type="checkbox"/>	<input type="checkbox"/>
Live3- Neutral	±2kV	120	<input checked="" type="checkbox"/>	<input type="checkbox"/>
Live1- PE	±2kV	120	<input checked="" type="checkbox"/>	<input type="checkbox"/>
Live2- PE	±2kV	120	<input checked="" type="checkbox"/>	<input type="checkbox"/>
Live3- PE	±2kV	120	<input checked="" type="checkbox"/>	<input type="checkbox"/>
Neutral- PE	±2kV	120	<input checked="" type="checkbox"/>	<input type="checkbox"/>
Live1- Live2- Live3- Neutral- PE	±2kV	120	<input checked="" type="checkbox"/>	<input type="checkbox"/>
DC Line	±2kV	120	<input checked="" type="checkbox"/>	<input type="checkbox"/>

Remark:

Calculated measurement uncertainty: 7.1%

STC (Dongguan) Company Limited

88 Fushih Men Road, Daxing, Dongguan, China. (Zip Code: 523 770)
Tel: (86 769) 8111 9668 Fax: (86 769) 8111 0222 E-mail: dgstc@dgstc.org Homepage: www.dgstc.org
This report shall not be reproduced unless with prior written approval from STC (Dongguan) Company Limited.
For Conditions of issuance of this test report, please refer to the coverleaf or Homepage.



STC Test Report

Date: 2016-04-01
No.: DMI22443

Page 49 of 60

3.2.5 Surge Immunity on AC Supply

Test Requirement: IEC 61000-4-5
Test Method: IEC 61000-4-5
Severity: Level 2 - 1.0kV (between phase & phase)
Level 3 - 2.0kV (between phase & earth)

Performance Criterion Requirement: B

Temperature: 21.6 °C
Humidity: 56.8 %

Test Date(s): 2016-03-22

Mode of Operation: 10% load mode

Test Method:

The test was performed in accordance with IEC 61000-4-5.

Test Procedure:

The EUT is a PV Inverter, the test was conducted during the 10% load test function to simulate the normal usage specified by the manufacturer.

Test Setup:

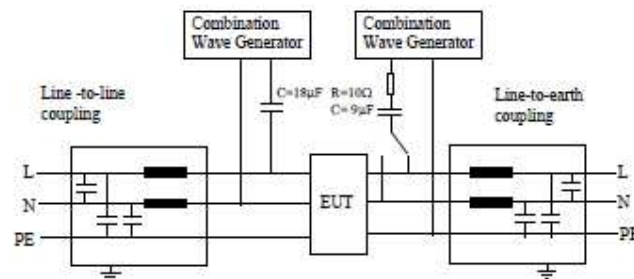

STC (Dongguan) Company Limited

88 Fushin Nan Road, Dongguan, Dongguan, China. (Zip Code: 523 770)
Tel: (86 768) 8111 8666. Fax: (86 768) 8111 8222. E-mail: dgstc@dgstc.org. Homepage: www.dgstc.org
This report shall not be reproduced unless with prior written approval from STC (Dongguan) Company Limited.
For Conditions of Issuance of this test report, please refer to the overleaf or Homepage.



STC Test Report

Date: 2016-04-01
No.: DMI22443

Page 50 of 60

Severity Levels for Surge Immunity:

Level	Open-circuit test voltage $\pm 10\%$
1	0.5 kV
2	1.0 kV
3	2.0 kV
4	4.0 kV

Results: Pass
Please refer to the following table for individual results.

Conductor	Level & Polarity	No. of Surge	Phase Angle	Surge Interval	Individual Results	
					Pass	Failed
Live1 - Neutral	$\pm 1.0\text{kV}$	5	0°	60s	<input checked="" type="checkbox"/>	<input type="checkbox"/>
			90°		<input checked="" type="checkbox"/>	<input type="checkbox"/>
			180°		<input checked="" type="checkbox"/>	<input type="checkbox"/>
			270°		<input checked="" type="checkbox"/>	<input type="checkbox"/>
Live2 - Neutral	$\pm 2.0\text{kV}$	5	0°	60s	<input checked="" type="checkbox"/>	<input type="checkbox"/>
			90°		<input checked="" type="checkbox"/>	<input type="checkbox"/>
			180°		<input checked="" type="checkbox"/>	<input type="checkbox"/>
			270°		<input checked="" type="checkbox"/>	<input type="checkbox"/>
Live3 - Neutral	$\pm 2.0\text{kV}$	5	0°	60s	<input checked="" type="checkbox"/>	<input type="checkbox"/>
			90°		<input checked="" type="checkbox"/>	<input type="checkbox"/>
			180°		<input checked="" type="checkbox"/>	<input type="checkbox"/>
			270°		<input checked="" type="checkbox"/>	<input type="checkbox"/>
Live1 - PE	$\pm 1.0\text{kV}$	5	0°	60s	<input checked="" type="checkbox"/>	<input type="checkbox"/>
			90°		<input checked="" type="checkbox"/>	<input type="checkbox"/>
			180°		<input checked="" type="checkbox"/>	<input type="checkbox"/>
			270°		<input checked="" type="checkbox"/>	<input type="checkbox"/>
Live2 - PE	$\pm 2.0\text{kV}$	5	0°	60s	<input checked="" type="checkbox"/>	<input type="checkbox"/>
			90°		<input checked="" type="checkbox"/>	<input type="checkbox"/>
			180°		<input checked="" type="checkbox"/>	<input type="checkbox"/>
			270°		<input checked="" type="checkbox"/>	<input type="checkbox"/>
Live3 - PE	$\pm 2.0\text{kV}$	5	0°	60s	<input checked="" type="checkbox"/>	<input type="checkbox"/>
			90°		<input checked="" type="checkbox"/>	<input type="checkbox"/>
			180°		<input checked="" type="checkbox"/>	<input type="checkbox"/>
			270°		<input checked="" type="checkbox"/>	<input type="checkbox"/>
Neutral - PE	$\pm 1.0\text{kV}$	5	0°	60s	<input checked="" type="checkbox"/>	<input type="checkbox"/>
			90°		<input checked="" type="checkbox"/>	<input type="checkbox"/>
			180°		<input checked="" type="checkbox"/>	<input type="checkbox"/>
			270°		<input checked="" type="checkbox"/>	<input type="checkbox"/>

Remark:
Calculated measurement uncertainty: 0.23kV

STC (Dongguan) Company Limited

88 Fumin Nan Road, Daling, Dongguan, China. (Zip Code: 523 770)
Tel: (86 769) 8111 9668 Fax: (86 769) 8111 0222 E-mail: dgstc@dgstc.org Homepage: www.dgstc.org
This report shall not be reproduced unless with prior written approval from STC (Dongguan) Company Limited.
For Conditions of Insurance of this test report, please refer to the overleaf or Homepage.



STC Test Report

Date: 2016-04-01
No.: DMI22443

Page 51 of 60

3.2.6 Continuous RF Immunity (150kHz to 80MHz)
 Test Requirement: IEC 61000-4-6
 Test Method: IEC 61000-4-6
 Severity: Level 3 - 10Vrms(emf) with 80% 1kHz AM

Performance Criterion Requirement: A

Temperature: 22.5 °C
 Humidity: 56.3 %
 Test Date(s): 2016-03-22
 Mode of Operation: 10% load mode

Test Method:
 The test was performed in accordance with IEC 61000-4-6.

Test Procedure:
 The EUT is a PV Inverter, the test was conducted during the 10% load test function to simulate the normal usage specified by the manufacturer.

Test Setup:

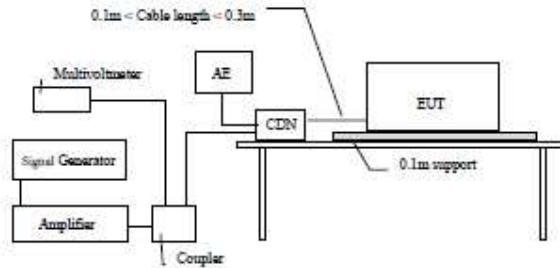

STC (Dongguan) Company Limited

88 Fumin Nan Road, Daling, Dongguan, China. (Zip Code: 523770)
 Tel: (86 769) 8111 9066 Fax: (86 769) 8111 8222 E-mail: dgstc@dgstc.org Homepage: www.dgstc.org
 This report shall not be reproduced unless with prior written approval from STC (Dongguan) Company Limited.
 For Conditions of issuance of this test report, please refer to the overleaf or Homepage.



STC Test Report

Date: 2016-04-01
No.: DMI22443

Page 52 of 60

Severity Levels for Continuous RF Immunity:

Frequency range 150kHz - 80MHz		
Level	Voltage level (emf)	
	U ₀ [dB(μV)]	U ₀ [V]
1	120	1
2	130	3
3	140	10

Results: Pass

Please refer to the following table for individual results.

DC Line:

Frequency (MHz)	Level (V _{rms})	Dwell Time (s)	Sweep rate (%)	Individual Results	
				Pass	Failed
150kHz - 80MHz	10	3	1	<input checked="" type="checkbox"/>	<input type="checkbox"/>

AC Mains:

Frequency (MHz)	Level (V _{rms})	Dwell Time (s)	Sweep rate (%)	Individual Results	
				Pass	Failed
150kHz - 80MHz	10	3	1	<input checked="" type="checkbox"/>	<input type="checkbox"/>

Remark:

Calculated measurement uncertainty: 2.3dB

STC (Dongguan) Company Limited

88 Fushin Nan Road, Daling, Dongguan, China. (Zip Code: 523 770)
Tel: (86 768) 8111 9888 Fax: (86 768) 8111 0222 E-mail: dgstc@dgstc.org Homepage: www.dgstc.org
This report shall not be reproduced unless with prior written approval from STC (Dongguan) Company Limited.
For Conditions of Issuance of this test report, please refer to the coverleaf or Homepage.



STC Test Report

Date: 2016-04-01
No.: DMI22443

Page 53 of 60

3.2.7 Power Frequency Magnetic Field

Test Requirement: IEC 61000-4-8
Test Method: IEC 61000-4-8
Severity: 30 A/m (Continuous)

Performance Criterion Requirement: A

Temperature: 23.1 °C
Humidity: 58.2 %

Test Date(s): 2016-03-22

Mode of Operation: 10% load mode

Test Method:

The test was performed in accordance with IEC 61000-4-8

Test Procedure:

The EUT is a PV Inverter, the test was conducted during the 10% load test function to simulate the normal usage specified by the manufacturer.

Test Setup:

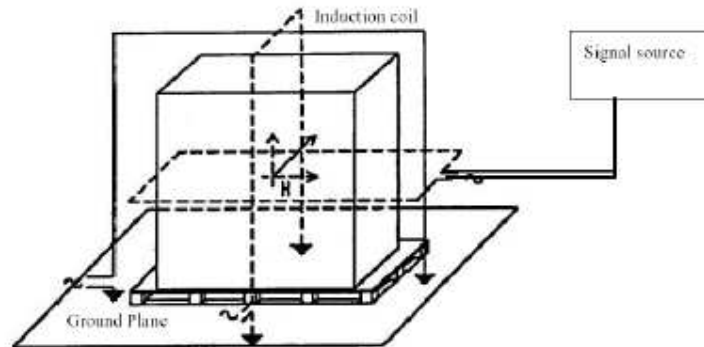

STC (Dongguan) Company Limited

88 Fushin Nan Road, Daling, Dongguan, China. (Zip Code: 523 770)
Tel: (86 768) 8111 9888 Fax: (86 768) 8111 0222 E-mail: dgstc@dgstc.org Homepage: www.dgstc.org
This report shall not be reproduced unless with prior written approval from STC (Dongguan) Company Limited.
For Conditions of Issuance of this test report, please refer to the coverleaf or Homepage.



STC Test Report

Date: 2016-04-01
No.: DMI22443

Page 54 of 60

Severity Levels for Power Frequency Magnetic Field:

Level	Magnetic field strength A/m
1	1
2	3
3	10
4	30
5	100
X ⁽¹⁾	special
NOTE 1 "X" is an open level. This level can be given in the product specification	

Results: Pass

Please refer to the following table for individual results.

Test Level	EUT Orientation	Individual Results	
		Pass	Failed
30 A/m (Continuous)	X, Y, Z	<input checked="" type="checkbox"/>	<input type="checkbox"/>

Remark:

Calculated measurement uncertainty: 7.1%

STC (Dongguan) Company Limited

88 Fushan Road, Daling, Dongguan, China. ZIP Code: 523 770
Tel: (86 769) 8111 9066 Fax: (86 769) 8111 8322 E-mail: dgstc@dgstc.org Homepage: www.dgstc.org
This report shall not be reproduced unless with prior written approval from STC (Dongguan) Company Limited.
For Conditions of Issuance of this test report, please refer to the coverleaf or Homepage.



STC Test Report

Date: 2016-04-01
No.: DMI22443

Page 55 of 60

3.2.8 Common Mode Disturbance

Test Requirement: IEC 61000-4-16
Test Method: IEC 61000-4-16
Severity: 100V, 300V

Performance Criterion Requirement: A

Temperature: 28.1 °C
Humidity: 51.6 %

Test Date(s): 2016-03-22

Mode of Operation: 10% load mode

Test Method:

The test was performed in accordance with IEC 61000-4-16

Test Procedure:

The EUT is a PV inverter, the test was conducted during the 10% load test function to simulate the normal usage specified by the manufacturer.

Test Setup:

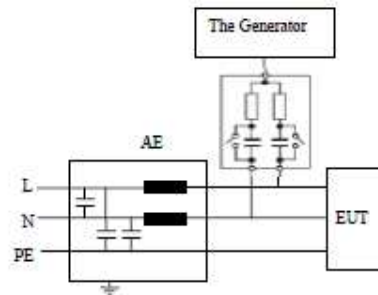

STC (Dongguan) Company Limited

88 Fumin Nan Road, Daling, Dongguan, China. (Zip Code: 523 770)
Tel: (86 769) 8111 9066 Fax: (86 769) 8111 8222 E-mail: dgstc@dgstc.org Homepage: www.dgstc.org
This report shall not be reproduced unless with prior written approval from STC (Dongguan) Company Limited.
For Conditions of issuance of this test report, please refer to the overleaf or Homepage.



STC Test Report

Date: 2016-04-01
No.: DMI22443

Page 56 of 60

Severity Levels for continuous disturbance:

Level	Open circuit test voltage V (r.m.s.)
1	1
2	3
3	10
4	30
X ⁽¹⁾	special

NOTE 1 "X" is an open level. This level may be defined in the product standard.

Severity Levels for for short duration disturbance:

Level	Open circuit test voltage V (r.m.s.)
1	10
2	30
3	100
4	300
X ⁽¹⁾	special

NOTE 1 "X" is an open level. This level may be defined in the product standard.

Results:
Please refer to the following table for individual results.

Pass

Short Duration (Common mode)

Test Terminal	Test Level V	Frequency Hz	Dwell Time	Individual Results	
				Pass	Failed
Output Power	300	50	2S	<input checked="" type="checkbox"/>	<input type="checkbox"/>

Short Duration (Difference mode)

Test Terminal	Test Level V	Frequency	Dwell Time	Individual Results	
				Pass	Failed
Output Power	100	50	2S	<input checked="" type="checkbox"/>	<input type="checkbox"/>

STC (Dongguan) Company Limited

88 Fumin Nan Road, Daling, Dongguan, China. (Zip Code: 523 770)
Tel: (86 769) 8111 9066 Fax: (86 769) 8111 8222 E-mail: dgstc@dgstc.org Homepage: www.dgstc.org
This report shall not be reproduced unless with prior written approval from STC (Dongguan) Company Limited.
For Conditions of issuance of this test report, please refer to the overleaf or Homepage.



STC Test Report

Date: 2016-04-01
No.: DMI22443

Page 57 of 60

3.2.9 Oscillatory Waves

Test Requirement: IEC 61000-4-18
Test Method: IEC 61000-4-18
Severity: 1kV; 2.5kV

Performance Criterion Requirement: B

Temperature: 25.1 °C
Humidity: 55.2 %

Test Date(s): 2016-03-22

Mode of Operation: 10% Load Mode

Test Method:

The test was performed in accordance with IEC 61000-4-18

Test Procedure:

The EUT is a PV inverter, the test was conducted during the 10% load test function to simulate the normal usage specified by the manufacturer.

Test Setup:

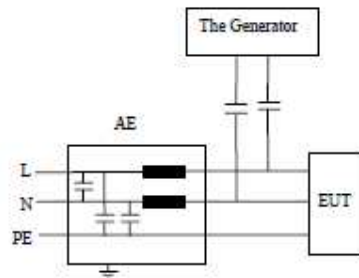

STC (Dongguan) Company Limited

88 Fumin Nan Road, Daxing, Dongguan, China. (Zip Code: 523 770)
Tel: (86 768) 8111 9666. Fax: (86 768) 8111 0222. E-mail: dgstc@dgstc.org. Homepage: www.dgstc.org
This report shall not be reproduced unless with prior written approval from STC (Dongguan) Company Limited.
For Conditions of Issuance of this test report, please refer to the overleaf or Homepage.



STC Test Report

Date: 2016-04-01
No.: DMI22443

Page 58 of 60

Severity Levels for Oscillatory Waves Field:

Test levels for the slow damped oscillatory wave(100KHz or 1MHz)

Level	Common mode kV	Differential mode kV
1	0.5	0.25
2	1	0.5
3	2*	1
4	-	-
X ^o	X	X

NOTE:

* The Value is increased to 2.5kV for substation equipment.

"X" is an open level, above, below or in-between the other levels. This level can be give in the product standard.

Test levels for the fast damped oscillatory wave (3MHz, 10MHz or 30MHz)

Level	Common mode kV
1	0.5
2	1
3	2
4	4
X ^o	X

NOTE :

"X" can be any level, above, below or in-between the other levels. This level can be give in the product standard.

Results:

Pass

Please refer to the following table for individual results.

Conductor	Level & Polarity	Oscillation Frequency	Number of Pulses	Surge Interval	Individual Results	
					Pass	Failed
Line1 - Neutral	±1.0kV	1MHz	400/s	60s	<input checked="" type="checkbox"/>	<input type="checkbox"/>
Line2 - Neutral	±1.0kV	1MHz	400/s	60s	<input checked="" type="checkbox"/>	<input type="checkbox"/>
Line3 - Neutral	±1.0kV	1MHz	400/s	60s	<input checked="" type="checkbox"/>	<input type="checkbox"/>
Line1 - PE	±2.5kV	1MHz	400/s	60s	<input checked="" type="checkbox"/>	<input type="checkbox"/>
Line2 - PE	±2.5kV	1MHz	400/s	60s	<input checked="" type="checkbox"/>	<input type="checkbox"/>
Line3 - PE	±2.5kV	1MHz	400/s	60s	<input checked="" type="checkbox"/>	<input type="checkbox"/>
Neutral - PE	±2.5kV	1MHz	400/s	60s	<input checked="" type="checkbox"/>	<input type="checkbox"/>

Remark:

Calculated measurement uncertainty: 7.1%

STC (Dongguan) Company Limited

88 Fushan Nan Road, Dongguan, Dongguan, China. (Zip Code: 523 770)
Tel: (86 768) 8111 8666. Fax: (86 768) 8111 8222. E-mail: dgstc@dgstc.org Homepage: www.dgstc.org
This report shall not be reproduced unless with prior written approval from STC (Dongguan) Company Limited.
For Conditions of Insurance of this test report, please refer to the overleaf or Homepage.



STC Test Report

Date: 2016-04-01
No.: DMI22443

Page 59 of 60

3.2.10 DC Voltage Dips and Interruptions
Test Requirement: IEC 61000-4-29
Test Method: IEC 61000-4-29

Performance Criterion Requirement: B

Temperature: 28.2 °C
Humidity: 51.6 %

Test Date(s): 2016-03-22

Mode of Operation: 10% load mode

Test Method:
The test was performed in accordance with IEC 61000-4-29

Test Procedure:
The EUT is a PV inverter, the test was conducted during the 10% load test function to simulate the normal usage specified by the manufacturer.

STC (Dongguan) Company Limited

88 Fuzhi Nan Road, Daxing, Dongguan, China. (Zip Code: 523 770)
Tel: (86 769) 8111 9668 Fax: (86 769) 8111 0322 E-mail: dgstc@dgstc.org Homepage: www.dgstc.org
This report shall not be reproduced unless with prior written approval from STC (Dongguan) Company Limited.
For Conditions of issuance of this test report, please refer to the coverleaf or Homepage.



STC Test Report

Date: 2016-04-01
No.: DMI22443

Page 60 of 60

**Severity Levels for DC Voltage Dips and Interruptions immunity:
Preferred test levels and durations for voltage dips**

Test	Test level % U _T	Duration (s)
Voltage dips	40 and 70 or %	0.01
		0.03
		0.1
		0.3
		1
		%

Preferred test levels and durations for short interruptions

Test	Test level % U _T	Duration (s)
Short interruptions	High impedance and/or Low impedance	0
		0.001
		0.003
		0.01
		0.03
		0.1
		0.3
		1
%		

Preferred test levels and durations for voltage variations

Test	Test level % U _T	Duration (s)
Voltage variations	85 and 120 or 80 and 120 or %	0.1
		0.3
		1
		3
		10
		%

Results: Pass
Please refer to the following table for individual results.

U_T = 300V d.c.

Test Level (% of U _T)	Duration (ms)	Event Interval (sec)	Duration (Times)	Individual Results	
				Pass	Failed
0%	50	10	3	<input checked="" type="checkbox"/>	<input type="checkbox"/>

Remarks:
Calculated measurement uncertainty: 0.13% of tested voltage
U_T - The nominal supply voltage

*****End of Test Report*****

STC (Dongguan) Company Limited

88 Fushin Han Road, Daxing, Dongguan, China. (Zip Code: 523 770)
Tel: (86 769) 8111 9668 Fax: (86 769) 8111 0322 E-mail: dgstc@dgstc.org Homepage: www.dgstc.org
This report shall not be reproduced unless with prior written approval from STC (Dongguan) Company Limited.
For Conditions of Insurance of this test report, please refer to the overleaf or Homepage.



STC Test Report

Date: 2016-04-01
No.: DMI22443

APPENDIX A

Page A1 of A3

List of Measurement Equipment

Radiated Emission

Equipment	Manufacturer	Model No.	Serial No.	Last Cal.	Next Cal.
EMI Test Receiver	Rohde&Schwarz	ESCI	100962	Mar. 04,16	Mar. 03,17
EMI Test Receiver	Rohde&Schwarz	ESCI	101418	Mar. 04,16	Mar. 03,17
Trilog-Broadband Antenna	SCHWARZBECK	VULB 9168	9168-555	Nov. 20, 15	Nov. 19, 16
Trilog-Broadband Antenna	SCHWARZBECK	VULB 9168	9168-554	Dec. 30, 15	Dec. 29, 16
BiLog Antenna	Teateq	CBL 6111D	27089	Jun. 23,15	Jun. 24,16
Signal Amplifier	Agilent	8447D	2944A10488	Jun. 23,15	Jun. 24,16
Signal Amplifier	Agilent	8447D	2944A11174	Jun. 23,15	Jun. 24,16
10m Semi-anechoic Chamber	CHANGLING	21.4m*12.1m*8.8m	NSEMC006	Jun. 10, 15	Jun. 09, 16
Test Software	ADT	ADT_Radiated_V 8.7.x	N/A	N/A	N/A

Conducted Emission

Equipment	Manufacturer	Model No.	Serial No.	Last Cal.	Next Cal.
EMI Test Receiver	Rohde&Schwarz	ESCS30	100199	May 11,15	May 10,16
Pulse Limiter	Rohde&Schwarz	ESH3-Z2	100168	Oct. 12,15	Oct. 11,16
Artificial Mains Network	Rohde&Schwarz	ESH2-Z5	100071	April 23,15	April 24,16
Voltage probe	SCHWARZBECK	TK 9421	TK 9421-176	Jan. 08,16	Jan. 07,17
Test software	ADT	ADT_Cond_V7.3.7	N/A	N/A	N/A

Harmonics/ Flicker

Equipment	Manufacturer	Model No.	Serial No.	Last Cal.	Next Cal.
PRECISION POWER ANALYZER	YOKOGAWA	WT3000	91M210852	Mar. 11,16	Mar. 10,17
Test Software	YOKOGAWA	IEC61000	N/A	N/A	N/A
REFERENCE IMPEDANCE NETWORK	Voltech	EUR	3018	Mar. 11,16	Mar. 10,17

Electro Static Discharge

Equipment	Manufacturer	Model No.	Serial No.	Last Cal.	Next Cal.
ESD Generator	TESEQ	NSG 437	279	Mar. 07, 16	Mar. 06, 17
Test Software	TESEQ	V03.03	N/A	N/A	N/A
ESD Generator	EM TEST	Dito	V1211112265	Mar. 17,16	Mar. 16,17
Test Software	EM TEST	V.2.31	N/A	N/A	N/A

STC (Dongguan) Company Limited

88 Fumin Nan Road, Dongguan, China. (Zip Code: 523 770).
Tel: (86 768) 8111 6666. Fax: (86 768) 8111 0222. E-mail: dgstc@dgstc.org Homepage: www.dgstc.org
This report shall not be reproduced unless with prior written approval from STC (Dongguan) Company Limited.
For Conditions of Issuance of this test report, please refer to the overleaf or Homepage.



STC Test Report

Date: 2016-04-01
No.: DMI22443

APPENDIX A

Page A2 of A3

Radiated Immunity

Equipment	Manufacturer	Model No.	Serial No.	Last Cal.	Next Cal.
Signal Generator	Agilent	N5181A	MY50142530	Oct. 12.15	Oct. 11.16
Bilog Antenna	Teiseq	CBL 6111D	27089	Jun. 25.15	Jun. 24.16
Antenna Log-Periodic	CORAD	ATS700M11G	0336821	N/A	N/A
Switch Controller	CORAD	SC1000	0337343	N/A	N/A
RF Power Meter	ESE	4242	13984	Nov. 09.15	Nov. 08.16
Power Sensor	ESE	51011EMC	35716	Nov. 09.15	Nov. 08.16
Power Sensor	ESE	51011EMC	35715	Nov. 09.15	Nov. 08.16
E-Field probe	Narda	NBM-520	2403/01B	May 28. 15	May 27. 16
Power Amplifier	TESEQ	CBA 1G-150	T44029	N/A	N/A
Power Amplifier	TESEQ	CBA 3G-100	T44030	N/A	N/A
Power Amplifier	TESEQ	CBA 6G-050	1041204	N/A	N/A
Dual Directional Coupler	TESEQ	C5982	95208	Nov. 09.15	Nov. 08.16
Dual Directional Coupler	TESEQ	C6187	95175	Nov. 09.15	Nov. 08.16
Dual Directional Coupler	TESEQ	CPH-274F	M251304-01	Nov. 09.15	Nov. 08.16
Test Software	ADT	BVADT_RS_V7.6.4-DG	N/A	N/A	N/A

Electrical Fast Transients

Equipment	Manufacturer	Model No.	Serial No.	Last Cal.	Next Cal.
EFT Tester	HAEFELY	PEFT4010	150546	May 11.15	May 10.16
EFT Coupling Clamp	HAEFELY	IP4A	150407	May 11.15	May 10.16
Test Software	HAEFELY	SWPE4010 1.22	N/A	N/A	N/A

Surge Immunity

Equipment	Manufacturer	Model No.	Serial No.	Last Cal.	Next Cal.
Combination Module	TESEQ AG	CDN 3061	1361	Jan. 08.16	Jan. 08.17
Telecom Surge Module	TESEQ AG	NSG 3060 Mainframe	1404	Jan. 08.16	Jan. 08.17
CDN	TESEQ	CDN HSS-2	34275	Nov. 13.15	Nov. 12.16
CDN	TESEQ	CDN 118	30741	Nov. 13.15	Nov. 12.16
Test Software	TESEQ	CDM 3061 0002.30	1361	N/A	N/A
Test Software	TESEQ	HVM 3060 0002.30	293	N/A	N/A

Continuous RF Immunity

Equipment	Manufacturer	Model No.	Serial No.	Last Cal.	Next Cal.
Signal Generator	Rohde&Schwarz	SME06	829498/006	Oct. 12.15	Oct. 11.16
CDN	Luthi	L-801M2/M3	2015	Sep. 09.15	Sep. 08.16
CDN(AUX)	TESEQ	CDN M016	27452	Nov. 13.15	Nov. 12.16
CDN	TESEQ	T200A	26944	Apr. 07.15	Apr. 06.16
CDN	TESEQ	T400A	26536	Apr. 07.15	Apr. 06.16
CDN	TESEQ	ST08A	32256	Apr. 07.15	Apr. 06.16
6dB 50Watt Attenuator	HUBER+SUHNER	5906.17.0005	303688	Oct. 12.15	Oct. 11.16
Signal Amplifier	HAEFELY	PAMP250	149594	N/A	N/A
Electromagnetic Injection Clamp	Luthi	EM101	35640	Sep. 09.15	Sep. 08.16
C/S Test System	HAEFELY	WinPAMP	NSEMC002	N/A	N/A
Test Software	ADT	BVADT_CS_V7.5.1	N/A	N/A	N/A

STC (Dongguan) Company Limited

88 Fushan Hill Road, Daxing, Dongguan, China. (Zip Code: 523 770)
Tel: (86 769) 8111 9668 Fax: (86 769) 8111 0222 E-mail: dgstc@dgstc.com Homepage: www.dgstc.com
This report shall not be reproduced unless with prior written approval from STC (Dongguan) Company Limited.
For Conditions of Issuance of this test report, please refer to the coverlet or Homepage.



STC Test Report

Date: 2016-04-01
No.: DM122443

APPENDIX A

Page A3 of A3

Power Frequency Magnetic Field Immunity

Equipment	Manufacturer	Model No.	Serial No.	Last Cal.	Next Cal.
Magnetic Field Tester	HAEFELY	MAG100.1	150579	Oct. 12, 15	Oct. 11, 16
Test Software	N/A	N/A	N/A	N/A	N/A

Voltage Dips and Short Interruptions Immunity

Equipment	Manufacturer	Model No.	Serial No.	Last Cal.	Next Cal.
DIPS Tester	HAEFELY	PLINE 1610	150370	April 08, 15	April 07, 16
5Kva ac Power Source	California Instruments	5001ix-400	55194	April 8, 15	April 7, 16
Harmonic/Flicker Test System	California Instruments	PACS-3	72134	April 8, 15	April 7, 16

Damped Oscillatory Wave Immunity

Equipment	Manufacturer	Model No.	Serial No.	Last Cal.	Next Cal.
Ringwave generator test system	EM TEST	OCS500N6	1404	Jan. 15, 16	Jan. 14, 17

Low Frequency Conduction Harassment Immunity

Equipment	Manufacturer	Model No.	Serial No.	Last Cal.	Next Cal.
Function generator	Agilent	33521A	MY50004592	Mar.04, 16	Mar.03, 17
Audio amplifier	AE Teklum	7224	7224-0713-0363	Mar.04, 16	Mar.03, 17
Voltmeter	Agilent	34401A	MY47063245	Feb.25, 16	Feb.24, 17
Audio coupling transformer	Solar	6220-1A	EMC201301	Feb.25, 16	Feb.24, 17

Remark:
N/A Not Applicable

STC (Dongguan) Company Limited

88 Fushin Nan Road, Daling, Dongguan, China. (Zip Code: 523770)
Tel: (86 769) 8111 9066 Fax: (86 769) 8111 8222 E-mail: dgstc@dgstc.org Homepage: www.dgstc.org
This report shall not be reproduced unless with prior written approval from STC (Dongguan) Company Limited.
For Conditions of issuance of this test report, please refer to the overleaf or Homepage.



STC Test Report

Date: 2016-04-01
No.: DMI22443

APPENDIX B

Page B1 of B10

PHOTOGRAPH (S) OF PRODUCT

View of The Product

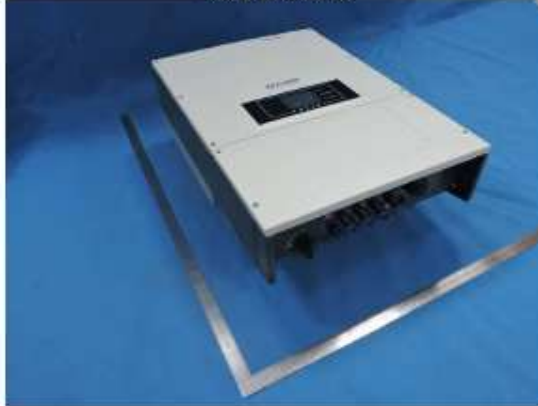

View of The Product

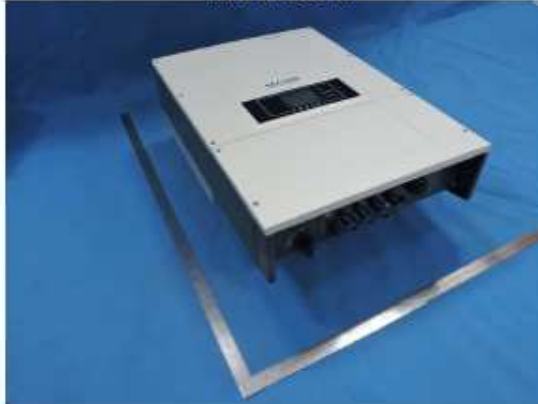

STC (Dongguan) Company Limited

88 Fushan Nan Road, Daxing, Dongguan, China. (Zip Code: 523 770)
Tel: (86 769) 8111 9666 Fax: (86 769) 8111 0222 E-mail: dgstc@dgstc.org Homepage: www.dgstc.org
This report shall not be reproduced unless with prior written approval from STC (Dongguan) Company Limited.
For Conditions of Issuance of this test report, please refer to the overleaf or Homepage.



STC Test Report

Date: 2016-04-01
No.: DM122443

APPENDIX B

Page B2 of B10

PHOTOGRAPH (S) OF PRODUCT

View of The Product



Inside View of The Product



STC (Dongguan) Company Limited

88 Fuzhi Nan Road, Daxing, Dongguan, China. (Zip Code: 523 770)
Tel: (86 769) 8111 9666 Fax: (86 769) 8111 0322 E-mail: dqstc@dgstc.org Homepage: www.dgstc.org
This report shall not be reproduced unless with prior written approval from STC (Dongguan) Company Limited.
For Conditions of issuance of this test report, please refer to the overleaf or Homepage.



STC Test Report

Date: 2016-04-01
No.: DM122443

APPENDIX B

Page B3 of B10

PHOTOGRAPH (S) OF PRODUCT

Inside View of The Product



Inside View of The Product



STC (Dongguan) Company Limited

88 Fumin Nan Road, Daling, Dongguan, China. (Zip Code: 523 770)
Tel: (86 769) 8111 9066 Fax: (86 769) 8111 8222 E-mail: dgstc@dgstc.org Homepage: www.dgstc.org
This report shall not be reproduced unless with prior written approval from STC (Dongguan) Company Limited.
For Conditions of issuance of this test report, please refer to the overleaf or Homepage.



STC Test Report

Date: 2016-04-01
No.: DM122443

APPENDIX B

Page B4 of B10

PHOTOGRAPH (S) OF PRODUCT

Inside View of The Product



Inner Circuit View



STC (Dongguan) Company Limited

88 Fulin Nan Road, Daxing, Dongguan, China. (Zip Code: 523 770)
Tel: (86 769) 8111 9666 Fax: (86 769) 8111 0322 E-mail: dgsts@dgsts.org Homepage: www.dgsts.org
This report shall not be reproduced unless with prior written approval from STC (Dongguan) Company Limited.
For Conditions of issuance of this test report, please refer to the coverleaf or Homepage.



STC Test Report

Date: 2016-04-01
No.: DM122443

APPENDIX B

Page B5 of B10

PHOTOGRAPH (S) OF PRODUCT

Inner Circuit View

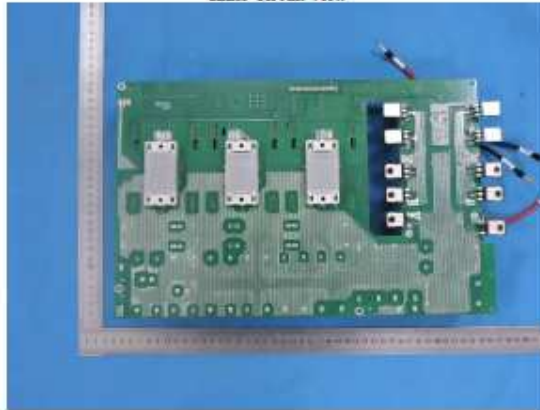

Inner Circuit View



STC (Dongguan) Company Limited

88 Fumin Nan Road, Daling, Dongguan, China. (Zip Code: 523 770)
Tel: (86 769) 8111 9066 Fax: (86 769) 8111 6333 E-mail: dgstc@dgstc.org Homepage: www.dgstc.org
This report shall not be reproduced unless with prior written approval from STC (Dongguan) Company Limited.
For Conditions of Issuance of this test report, please refer to the worksheet or Homepage.



STC Test Report

Date: 2016-04-01
No.: DM122443

APPENDIX B

Page B6 of B10

PHOTOGRAPH (S) OF PRODUCT

Inner Circuit View

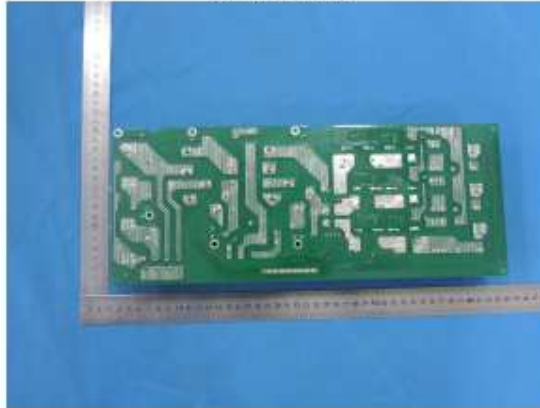

Inner Circuit View



STC (Dongguan) Company Limited

88 Fuzhi Nan Road, Dongguan, Dongguan, China. (Zip Code: 523 770)
Tel: (86 769) 8111 8666. Fax: (86 769) 8111 8222. E-mail: dgate@stc.org Homepage: www.dgate.org
This report shall not be reproduced unless with prior written approval from STC (Dongguan) Company Limited.
For Conditions of Issuance of this test report, please refer to the overleaf or Homepage.



STC Test Report

Date: 2016-04-01
No.: DM122443

APPENDIX B

Page B7 of B10

PHOTOGRAPH (S) OF PRODUCT

Inner Circuit View

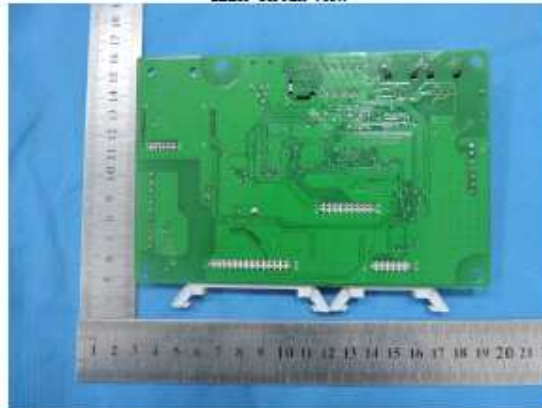

Inner Circuit View



STC (Dongguan) Company Limited

88 Fulin Nan Road, Daxing, Dongguan, China. (Zip Code: 523 770)
Tel: (86 769) 8111 9666 Fax: (86 769) 8111 0322 E-mail: dqstc@dgstc.org Homepage: www.dgstc.org
This report shall not be reproduced unless with prior written approval from STC (Dongguan) Company Limited.
For Conditions of issuance of this test report, please refer to the coverleaf or Homepage.



STC Test Report

Date: 2016-04-01
No.: DM122443

APPENDIX B

Page B8 of B10

PHOTOGRAPH (S) OF PRODUCT

Inner Circuit View



Inner Circuit View

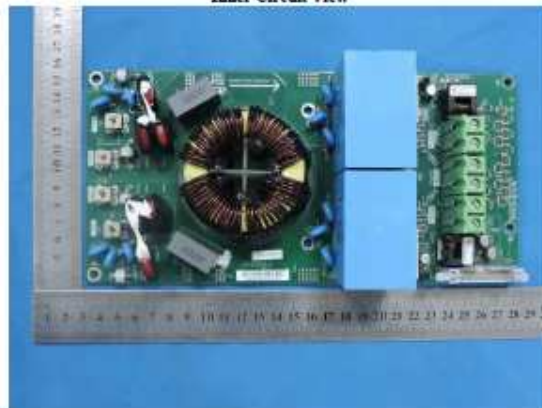

STC (Dongguan) Company Limited

88 Fulin Nan Road, Daling, Dongguan, China. (Zip Code: 523 770)
Tel: (86 769) 8111 9865 Fax: (86 769) 8111 8322 E-mail: dgstc@dgstc.org Homepage: www.dgstc.org
This report shall not be reproduced unless with prior written approval from STC (Dongguan) Company Limited.
For Conditions of issuance of this test report, please refer to the overleaf or Homepage.



STC Test Report

Date: 2016-04-01
No.: DM122443

APPENDIX B

Page B9 of B10

PHOTOGRAPH (S) OF PRODUCT

Inner Circuit View



Inner Circuit View

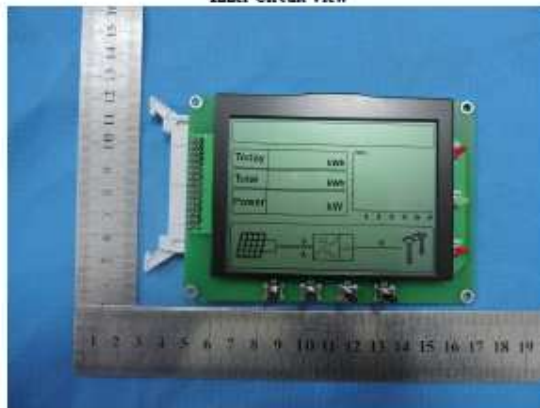

STC (Dongguan) Company Limited

88 Fanchi Nan Road, Daxing, Dongguan, China. (Zip Code: 523 770)
Tel: (86 769) 8111 6666 Fax: (86 769) 8111 6222 E-mail: dgstc@dgstc.org Homepage: www.dgstc.org
This report shall not be reproduced unless with prior written approval from STC (Dongguan) Company Limited.
For Conditions of Issuance of this test report, please refer to the overleaf or Homepage.



STC Test Report

Date: 2016-04-01
No.: DM122443

APPENDIX B

Page B10 of B10

PHOTOGRAPH (S) OF PRODUCT

Inner Circuit View



STC (Dongguan) Company Limited

88 Fulin Nan Road, Daxing, Dongguan, China. (Zip Code: 523 770)
Tel: (86 769) 8111 9666 Fax: (86 769) 8111 0322 E-mail: dgpc@dgpc.org Homepage: www.dgpc.org
This report shall not be reproduced unless with prior written approval from STC (Dongguan) Company Limited.
For Conditions of issuance of this test report, please refer to the overleaf or homepage.



STC Test Report

Conditions of Issuance of Test Reports

1. All samples and goods are accepted by The Hong Kong Standards & Testing Centre Limited (the "Company") solely for testing and reporting in accordance with the following terms and conditions. The Company provides its services on the basis that such terms and conditions constitute express agreement between the Company and any person, firm or company requesting its services (the "Clients").
2. Any report issued by the Company as a result of this application for testing service (the "Report") shall be issued in confidence to the Clients and the Report will be strictly treated as such by the Company. It may not be reproduced either in its entirety or in part and it may not be used for advertising or other unauthorized purposes without the written consent of the Company. The Clients to whom the Report is issued may, however, show or send it, or a certified copy thereof prepared by the Company to his customer, supplier or other persons directly concerned. The Company will not, without the consent of the Clients, enter into any discussion or correspondence with any third party concerning the contents of the Report, unless required by the relevant governmental authorities, laws or court orders.
3. The Company shall not be called or be liable to be called to give evidence or testimony on the Report in a court of law without its prior written consent, unless required by the relevant governmental authorities, laws or court orders.
4. The Report refers only to the sample tested and does not apply to the bulk, unless the sampling has been carried out by the Company and is stated as such in the Report.
5. In the event of the improper use of the report as determined by the Company, the Company reserves the right to withdraw it, and to adopt any other additional remedies which may be appropriate.
6. Sample submitted for testing are accepted on the understanding that the Report issued cannot form the basis of, or be the instrument for, any legal action against the Company.
7. The Company will not be liable for or accept responsibility for any loss or damage howsoever arising from the use of information contained in any of its Reports or in any communication whatsoever about its said tests or investigations.
8. Clients wishing to use the Report in court proceedings or arbitration shall inform the Company to that effect prior to submitting the sample for testing.
9. Subject to the variable length of retention time for test data and report stored hereinto as to otherwise specifically required by individual accreditation authorities, the Company will only keep the supporting test data and information of this test report for a period of three years. The data and information will be disposed of after the aforementioned retention period has elapsed. Under no circumstances shall we provide any data and information which has been disposed of after the retention period. Under no circumstances shall we be liable for damages of any kind, including (but not limited to) compensatory damages, lost profits, lost data, or any form of special, incidental, indirect, consequential or punitive damages of any kind, whether based on breach of contract of warranty, tort (including negligence), product liability or otherwise, even if we are informed in advance of the possibility of such damages.
10. Issuance records of the Report are available on the internet at www.stc-group.org. Further enquiry of validity or verification of the Reports should be addressed to the Company.

Annex 2

Pictures of the unit

Enclosure front view

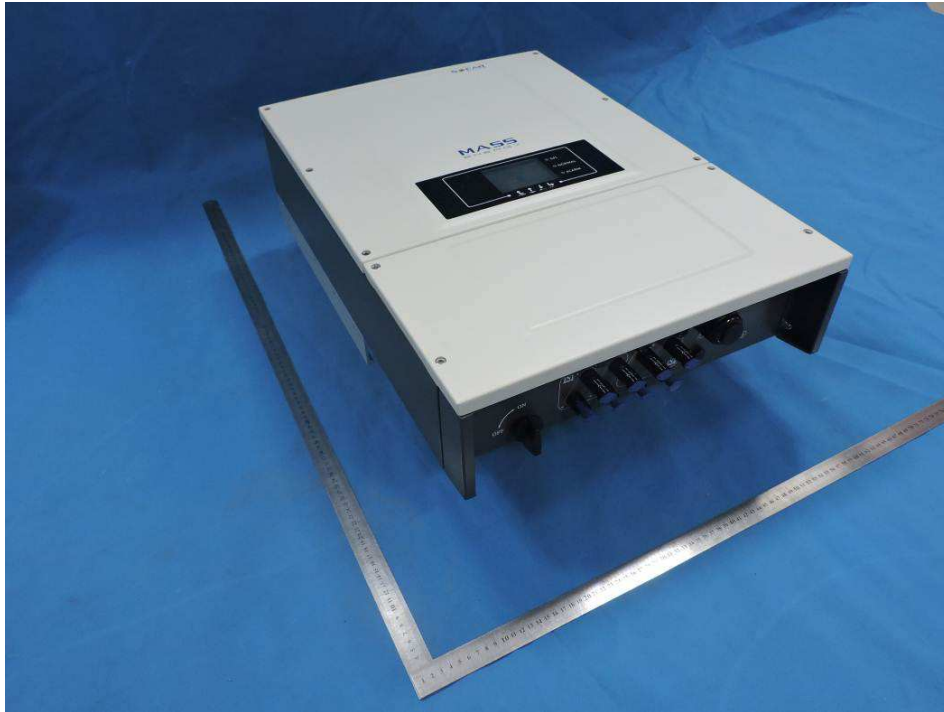

Enclosure rear view

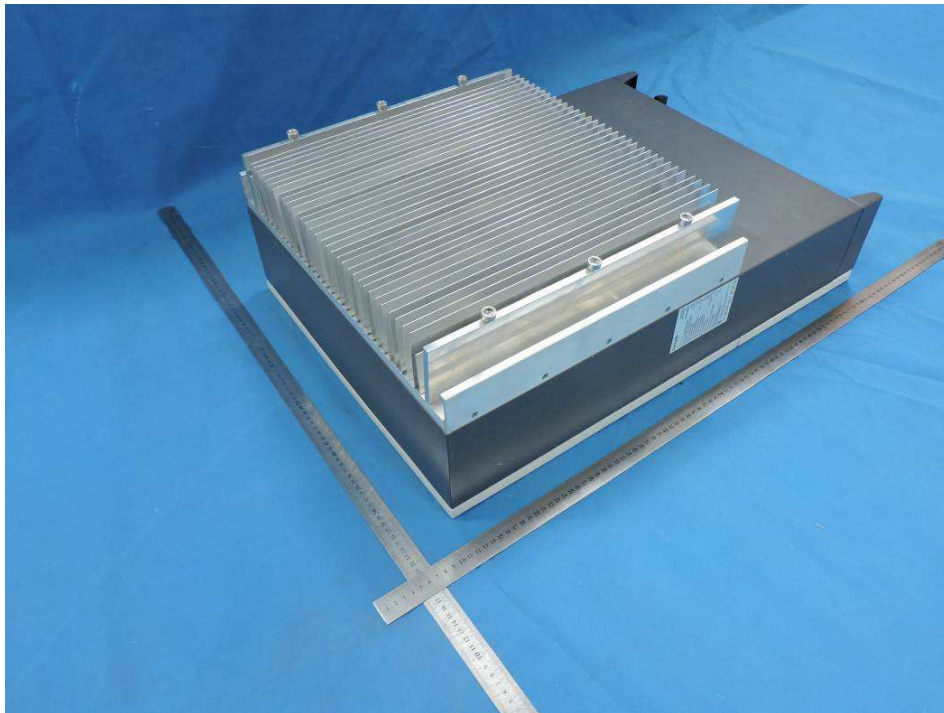

Enclosure bottom view



Internal view-1

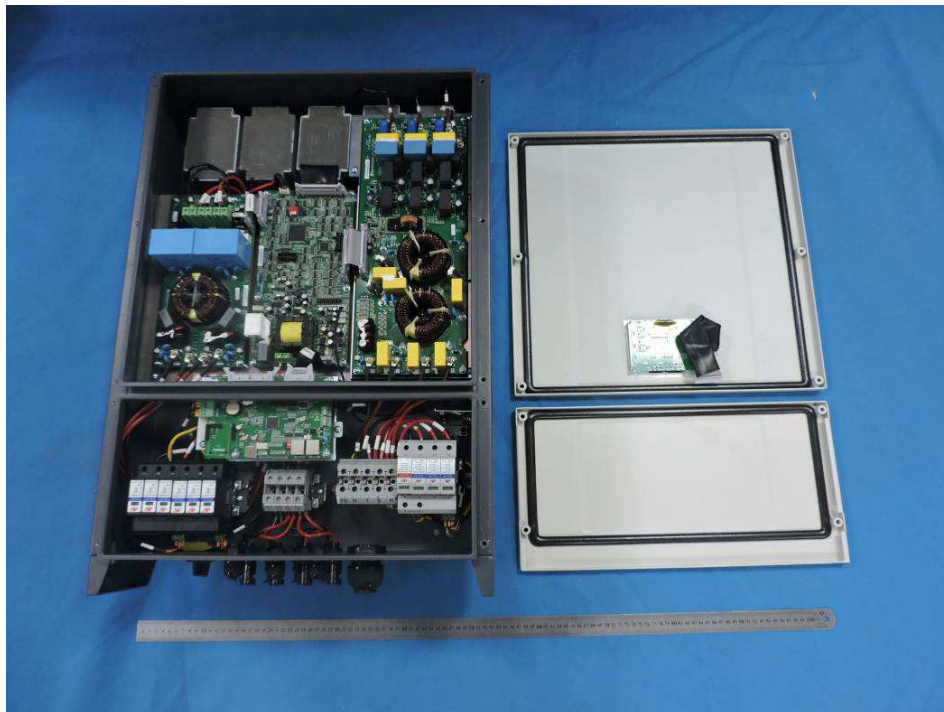

Internal view-2

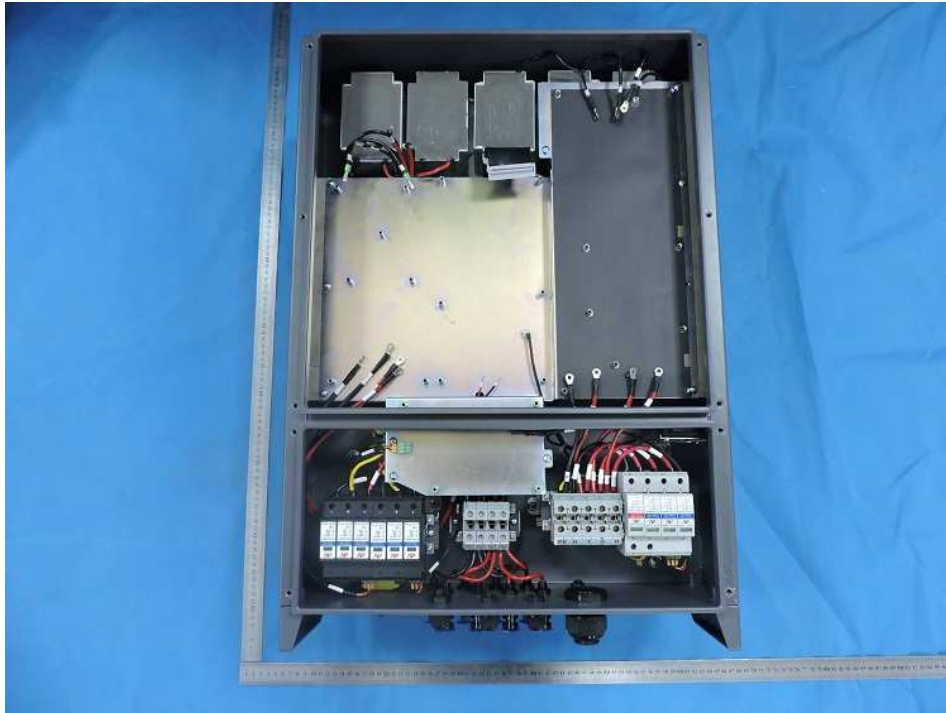

Internal view-3



Internal view-4



Main power board component side view

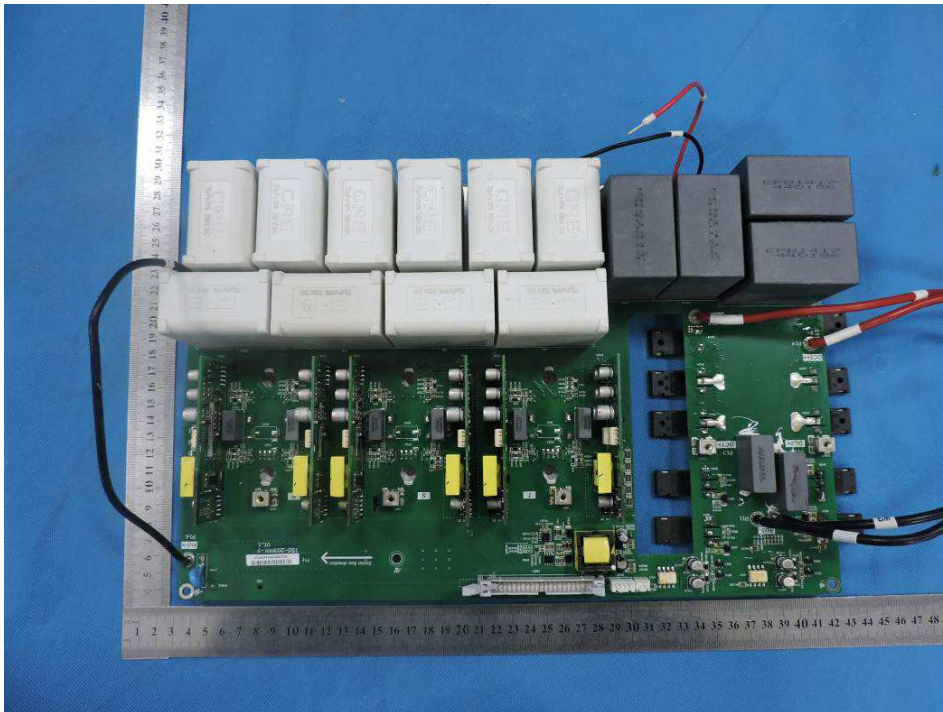

Main power board solder side view

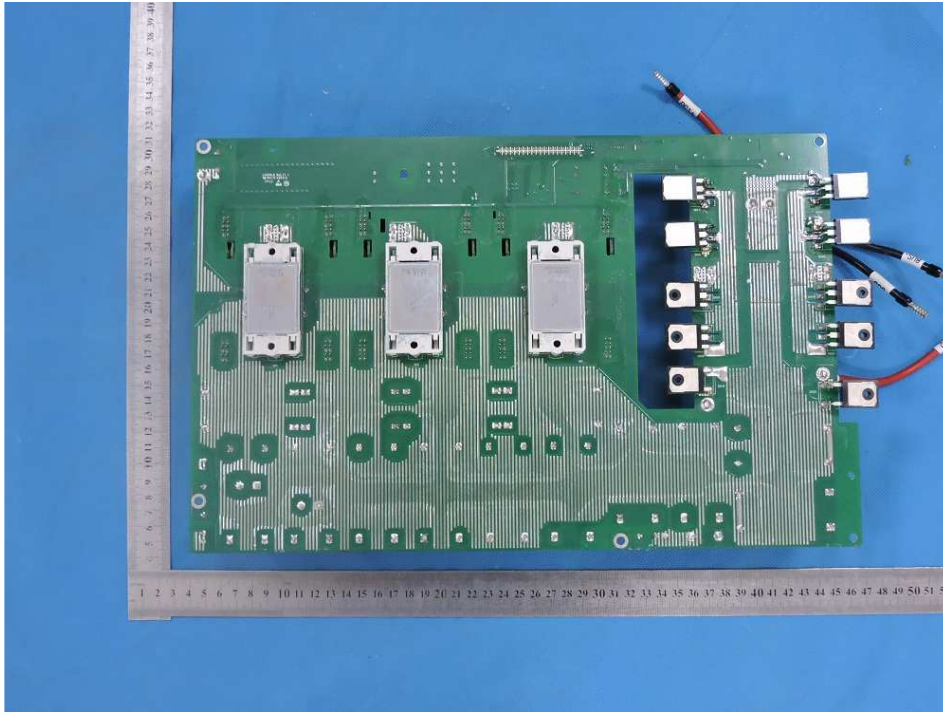

Control board component side view

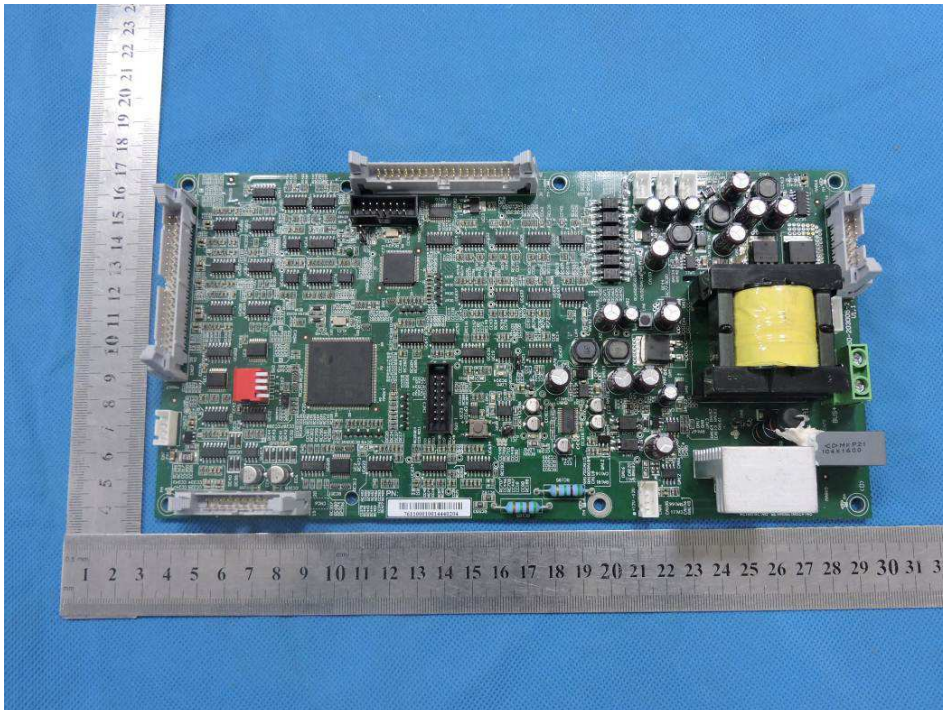

Control board solder side view

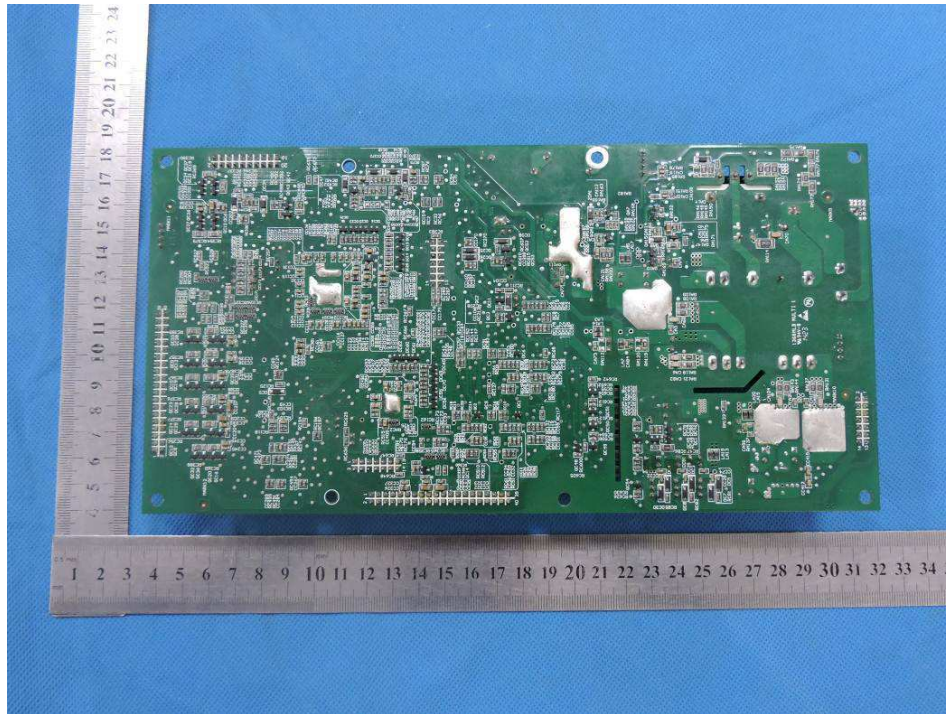

Display board component side view

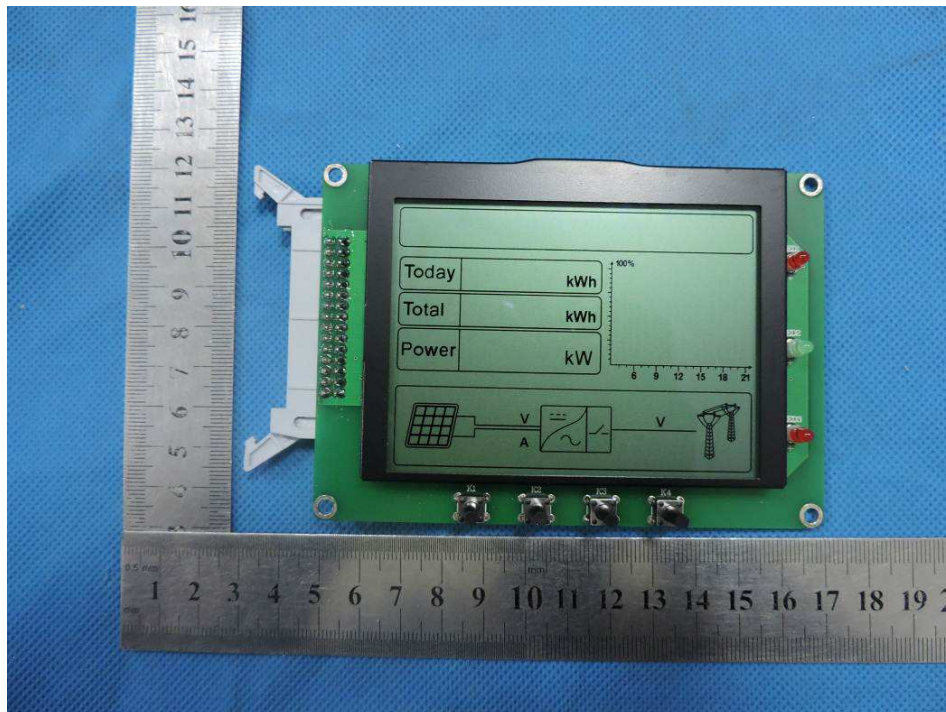

Display board solder side view

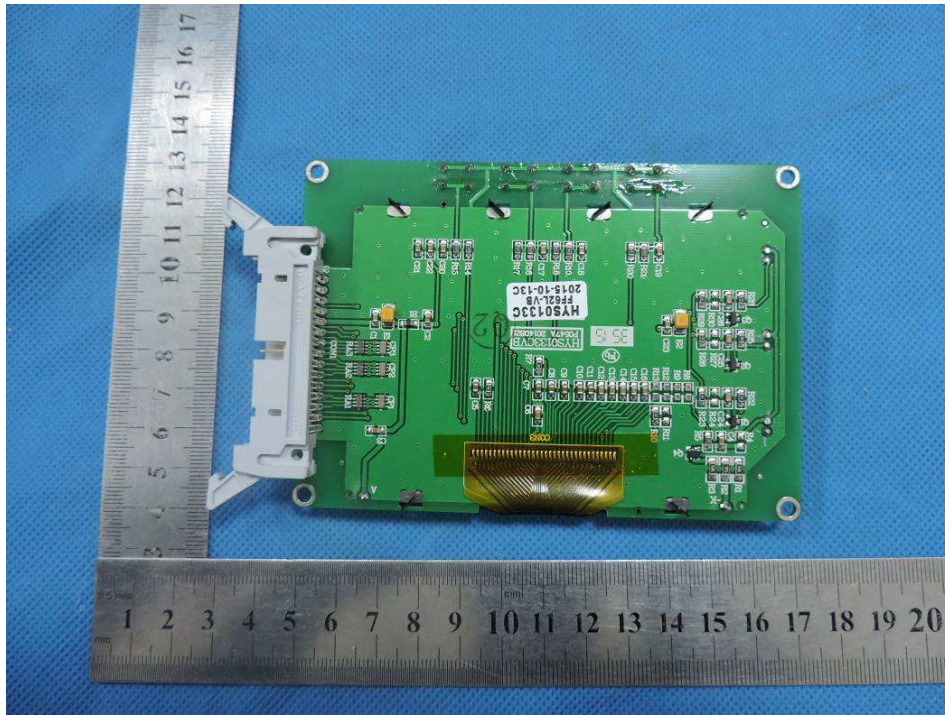

Communication board component side view

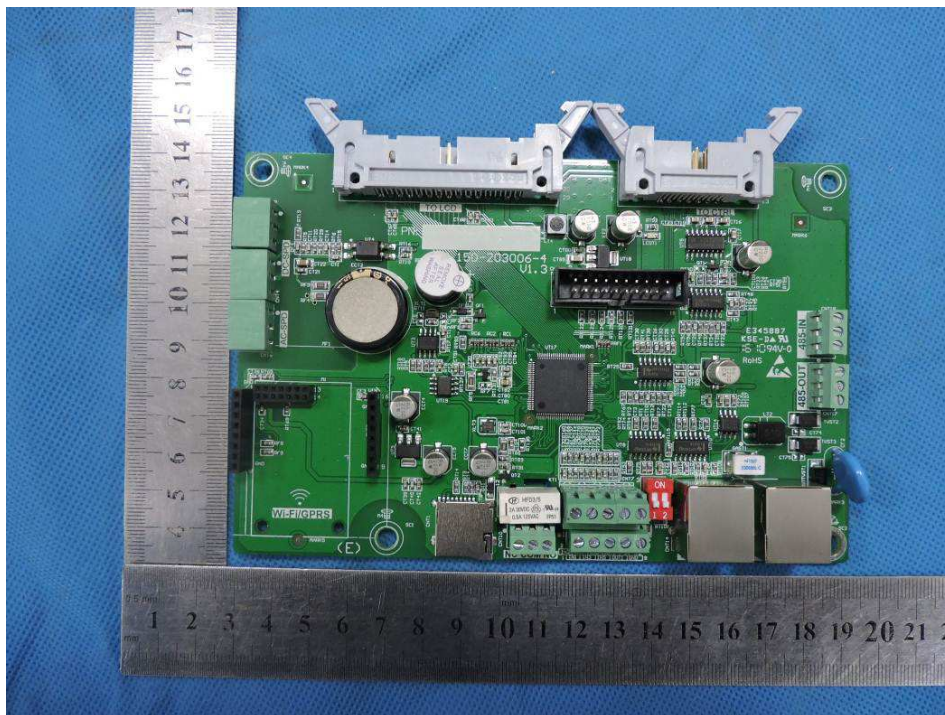

Communication board solder side view

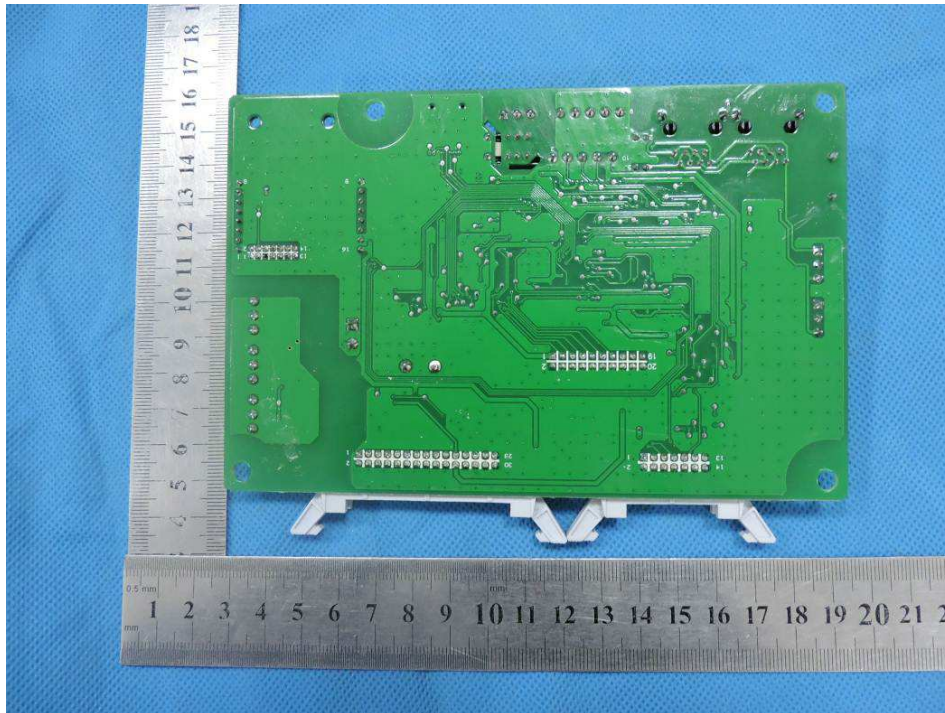

AC EMI board component side view

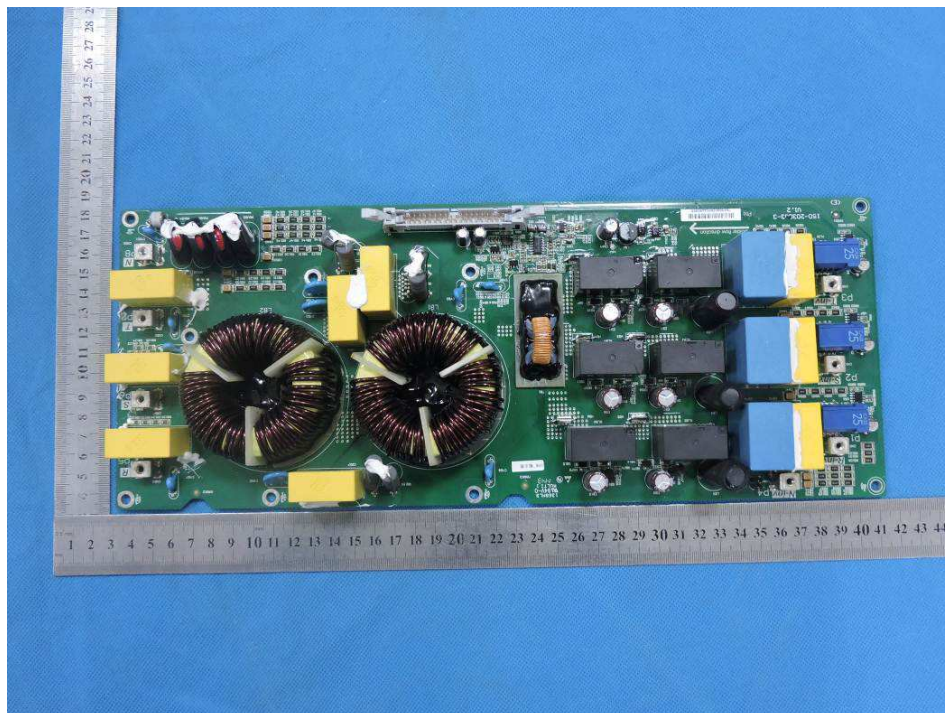

AC EMI board solder side view

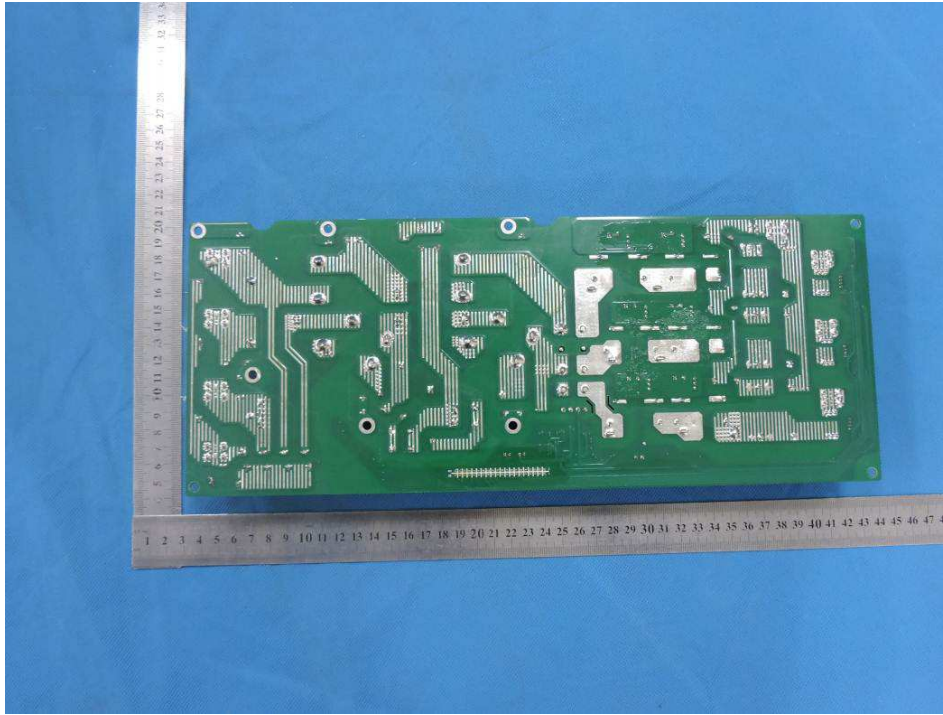

DC EMI board component side view

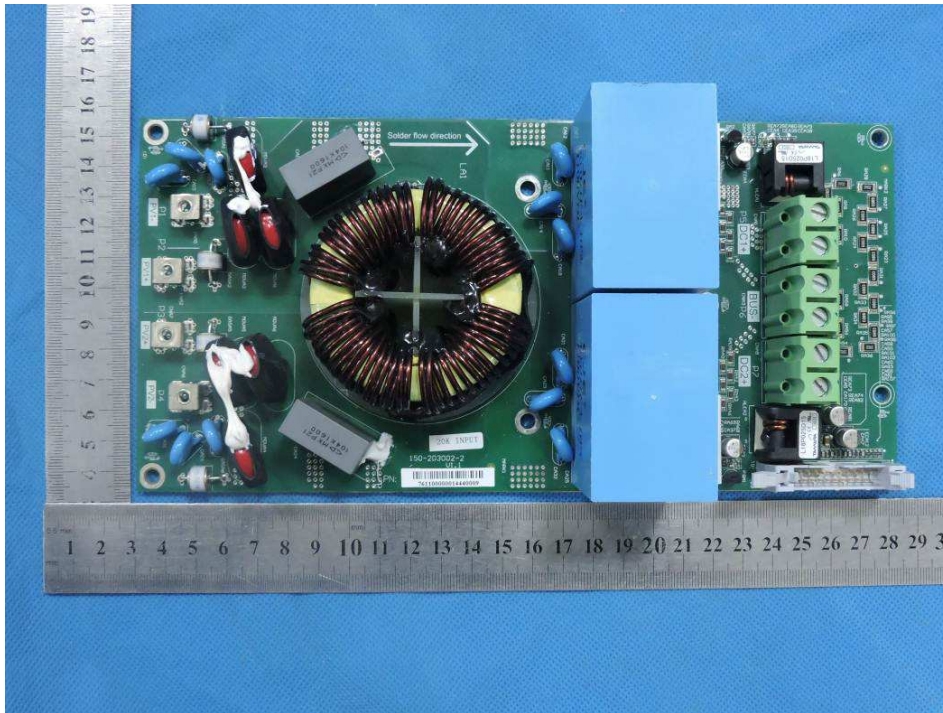

DC EMI board solder side view

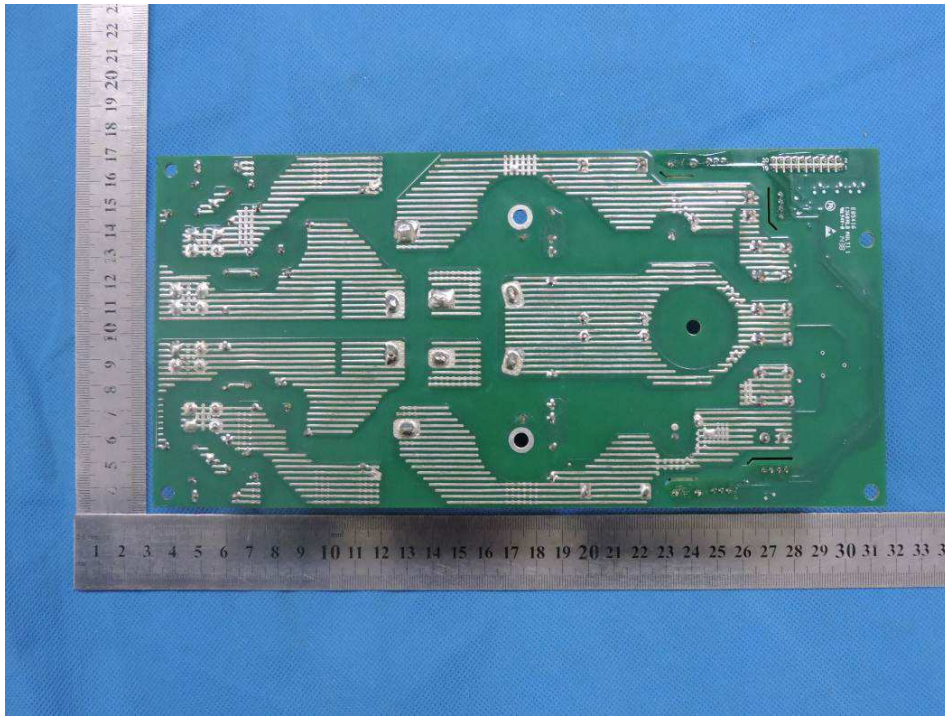

Annex 3

Test equipment list

Testing Location: Bureau Veritas Shenzhen Co., Ltd. Dongguan Branch
Date(s) of performance test: 2016-07-21 to 2017-08-03

Equipment	Internal no.:	Manufacturer:	Type:	Serial no.:	Last calibration
AC Source	A7040019DG	Chroma	61512	61512000439	Monitored by Power Analyzer
AC Source	A7040020DG	Chroma	61512	61512000438	
DC Simulation Power Supply	A7040016DG	Chroma	62150H- 1000S	62150EF00490	
DC Simulation Power Supply	A7040021DG	Chroma	62150H- 1000S	62150EF00609	
RLC Load	A7150027DG	Qunling	ACLT-3803H	93VOO2869	
Power Analyzer	A4080002DG	YOKOGAWA	WT3000	91M210852	Jan. 06, 2017
Four Channel Digital Phosphor Oscilloscope	A4089003DG	Tektronix	DPO4104B	C010624	Oct. 11, 2016
Eight Channel Digital Phosphor Oscilloscope	A4089017DG	YOKOGAWA	DL850	91N726247	Sep. 08, 2016
Oscilloscope probel	A4089008DG	Tektronix	TPP1000	C008230	Dec. 15, 2016
ScopeCorder	A4089009DG	Tektronix	TPP1000	C008231	Dec. 14, 2016
Current transducer	A1060007DG	YOKOGAWA	CT200	1130700012	Nov. 29, 2016
Current transducer	A1060008DG	YOKOGAWA	CT200	1130700017	Nov. 23, 2016
Current transducer	A1060012DG	YOKOGAWA	CT200	1130700018	Nov. 15, 2016
Impulse Test Generator	A6600004DG	COMPLIANCE WEST	10*700-7	431250	Jan. 03, 2017
Withstanding Voltage/Insulation	A6600007DG	KIKUSUI	TOS9201	SJ001948	Jan. 03, 2017
Temp. & Humi. Chamber	D1020009DG	Zhongzhi	CZ-A-3375A	Z412018	Jan. 03, 2017
Insulation Tester	A6610001DG	Qingdao YIDI	MN35B	03MN11063	Dec. 15,2016